

D: Batteriewechsel. Batterien enthalten. GB: Battery exchange. Batteries included. F: Changement des piles. Piles comprises. I: Cambio delle batterie. Batterie incluse. NL: Batterijwisselen. Inclusief batterijen. E: Cambio de pilas. Pilas incluidas. P: Toçar de pilha. Pilhas incluidas. DK: Batteriveksel. Batterier medfølger. S: Batteribyte. Batterier ingår. FIN: Paristojen vaihto. Sisältää paristot. N: Batteriskift. Batterier inkludert. H: Elemcsere. Elemekkel együtt. CZ: Výměna baterie. Baterie jsou přiloženy. PL: Wymiana baterii. Z bateriami. GR: Αλλαγή μπαταριών. Οι μπαταρίες περιλαμβάνονται. TR: Pili değiřimi. İçinde pili bulunmaktadı. SI: Zamenjava baterij. Vsebuje baterije. HRV: Promjena baterija. Baterije sadrđane u isporuci. SK: Výměna batérií. Obsahuje batérie. BG: Смяна на батериите. Съдържа батерии. RO: Schimbul bateriilor. Bateriile sunt cuprinse în conținut. UA: Заміна акумуляторів. 3 батарейки в комплекті. EST: Patareid vahetus. Patareid on kaasas. LT: Baterijų keitimas. Paruođama su baterijomis. LV: Bateriju nomaiņa. Baterijas ir. AR: استبدال البطارية. هذه اللصبة شاملة البطاريات.

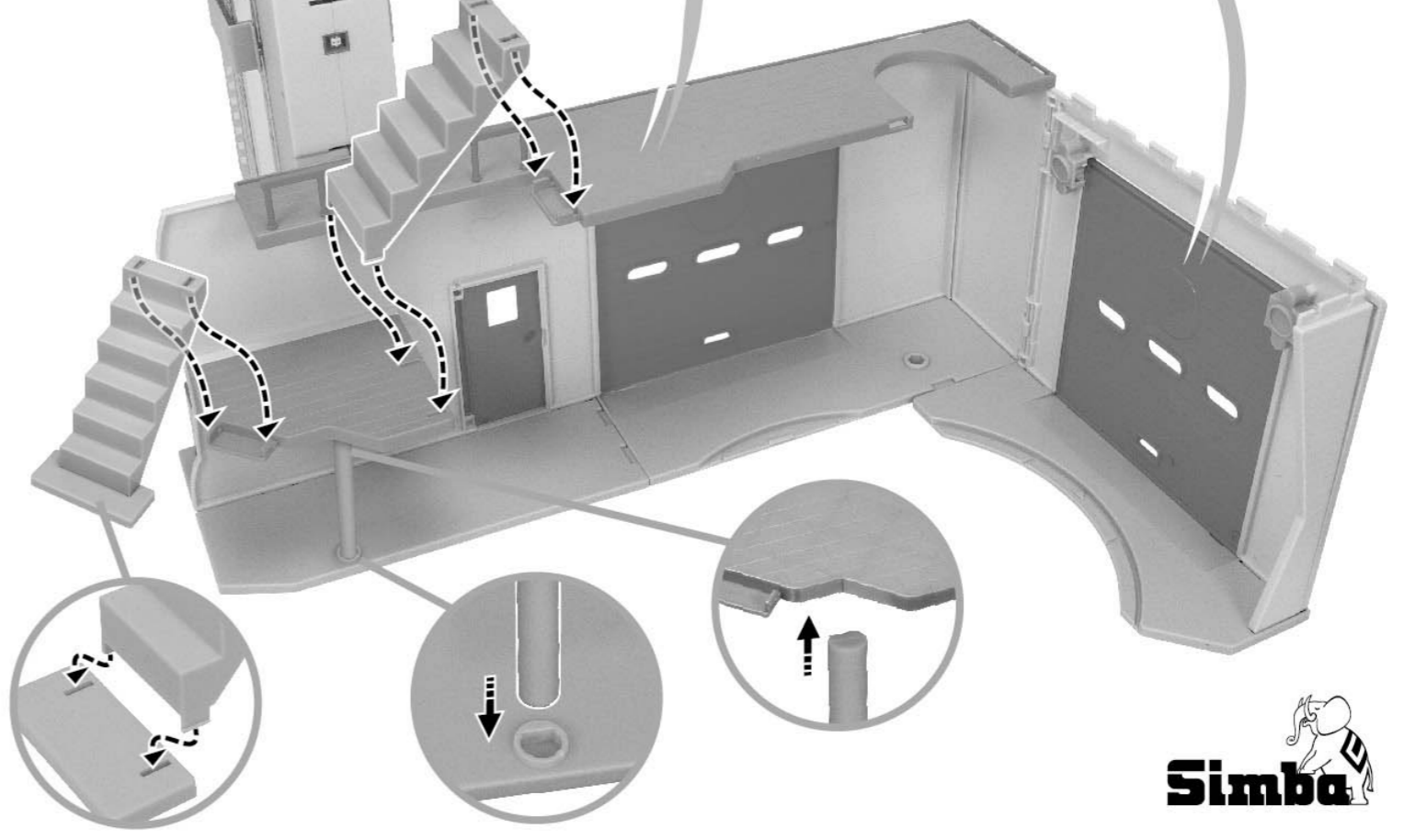

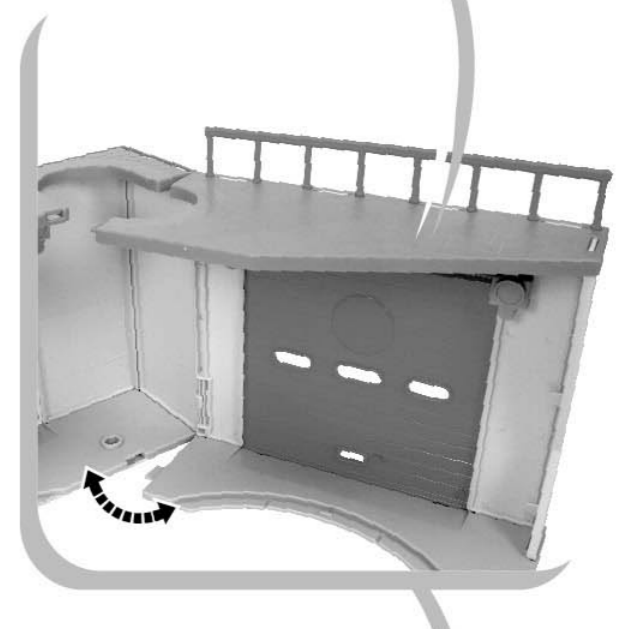

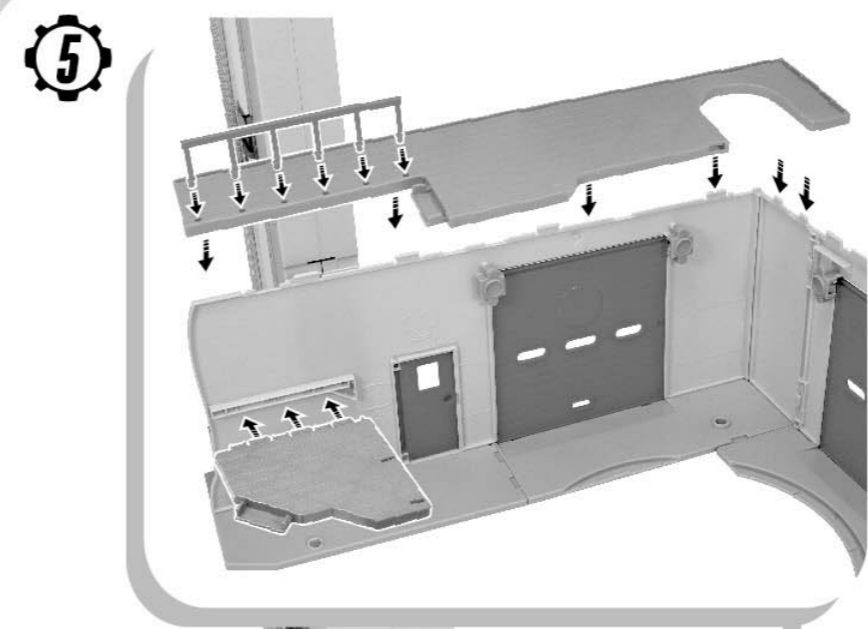
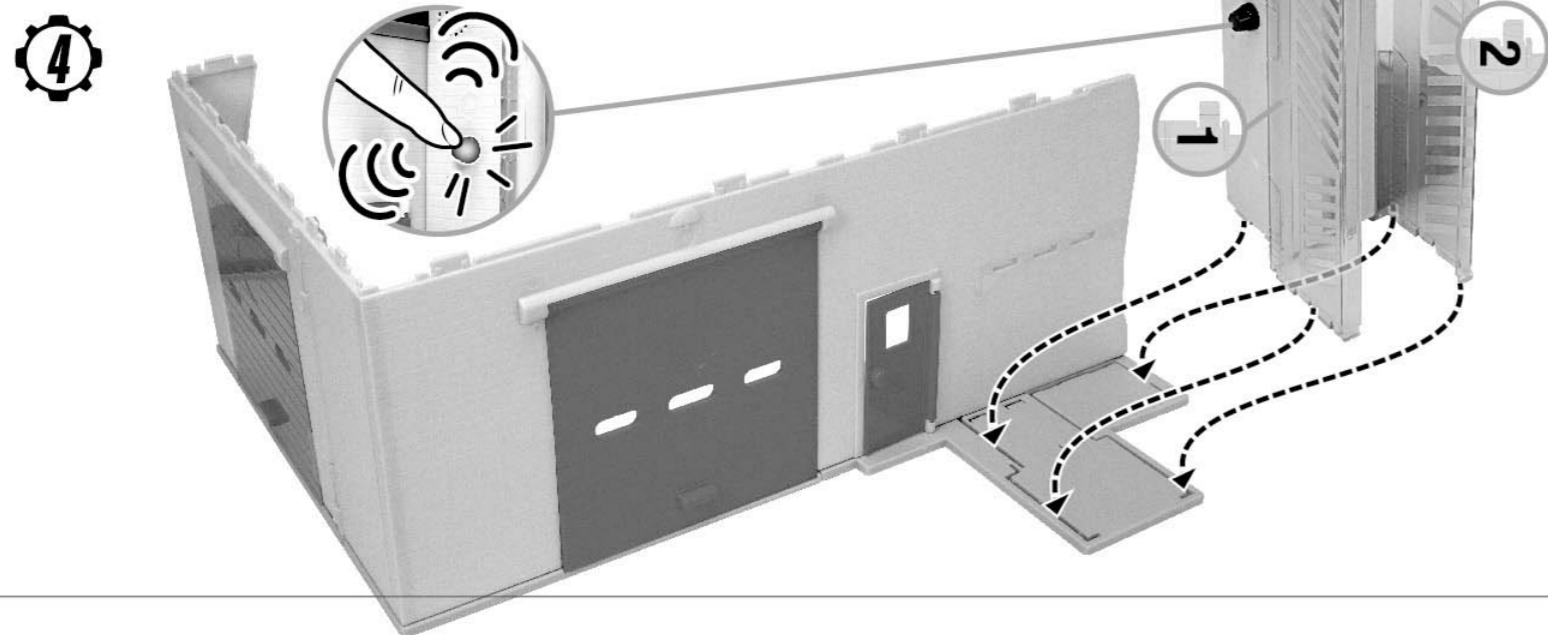
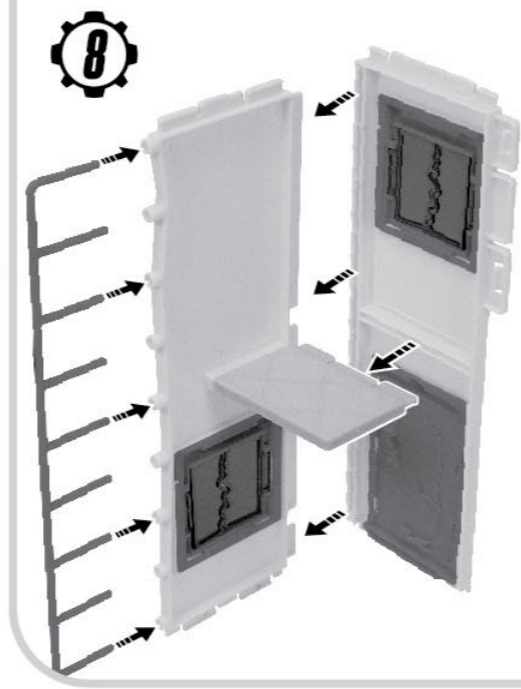
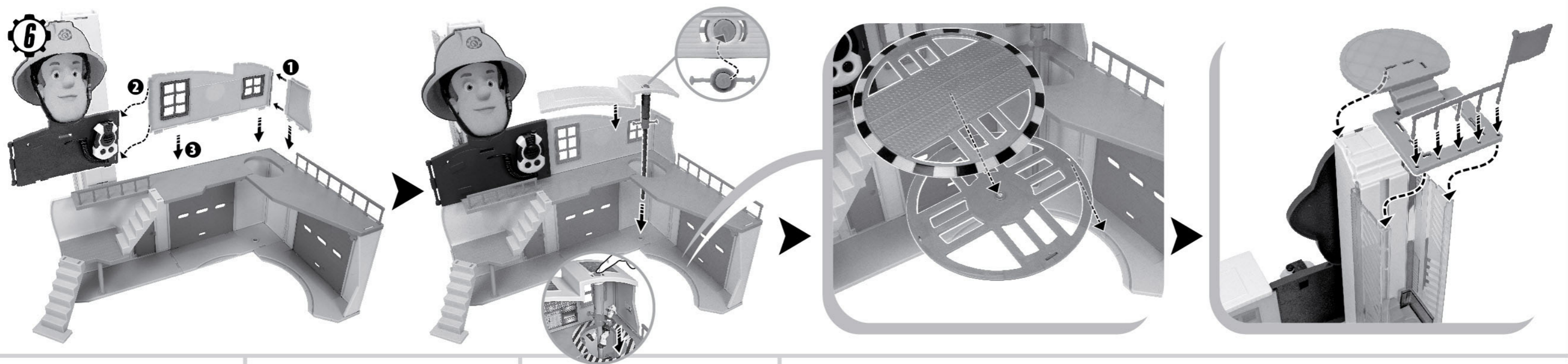
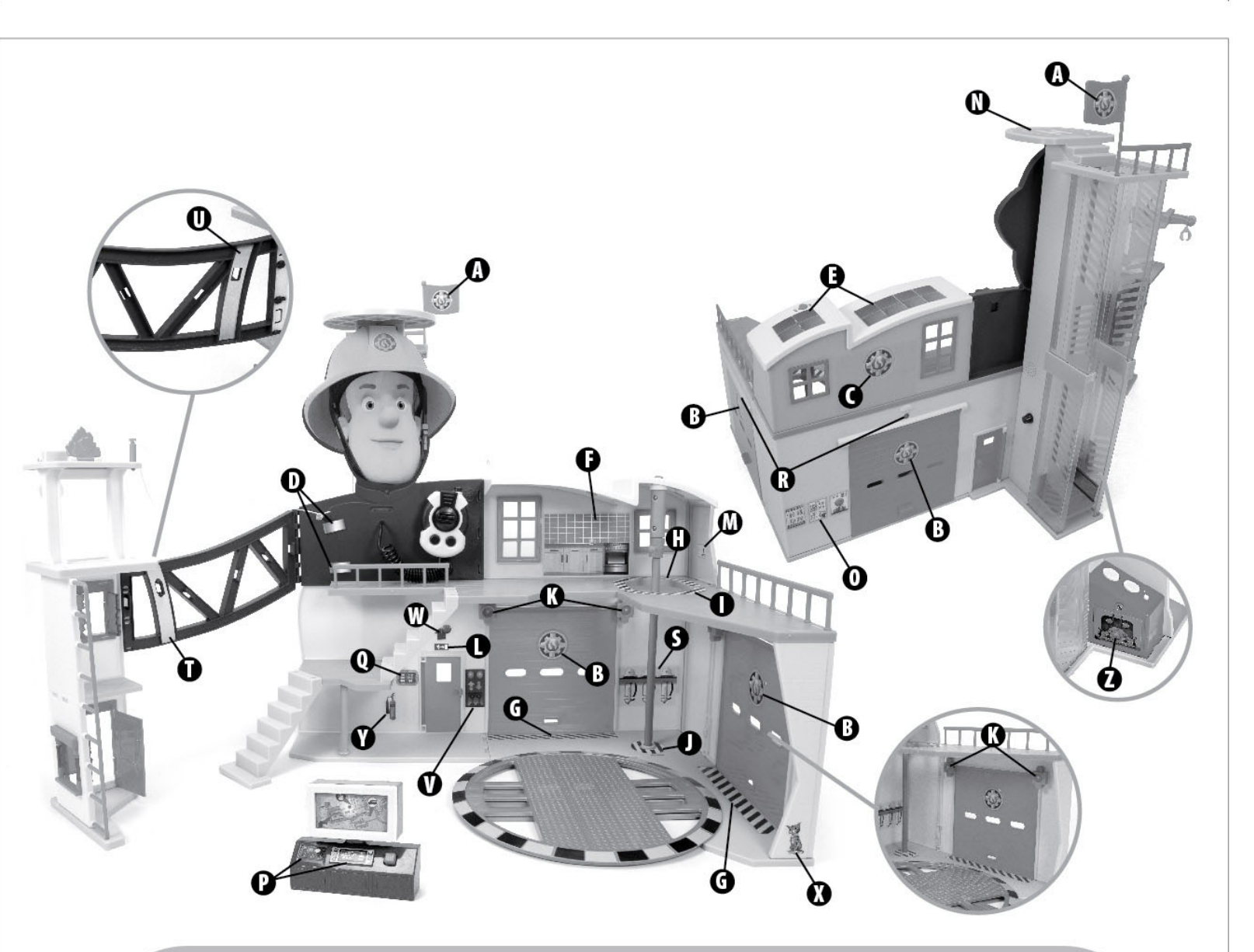

## MEGA FIRE STATION XXL

AGES  
3+

D: ACHTUNG! Muss von Erwachsenen montiert werden. GB: WARNING! Must be assembled by an adult. F: ATTENTION ! A monter par un adulte. I: AVVERTENZA! Deve essere montato da un adulto. NL: WAARSCHUWING! Dient door volwassenen gemonteerd worden. E: ¡ADVERTENCIA! Debe ser montado por personas adultas. P: ATENÇÃO! Tem de ser montado por adultos. DK: ADVARSEL! Skal samles af voksne. S: VARNING! Måste monteras av vuxna. FIN: VAROITUS! Ainoastaan aikuisen koottavaksi. N: ADVARSEL! Må monteres av voksne. H: FIGYELMEZTETES! Csak felnőtt felügyelete mellett használható. CZ: UPOZORNĚNÍ! Montáž provede dospělá osoba. PL: OSTRZEŻENIE! Musi być montowany przez dorosłych. GR: ΠΡΟΕΙΔΟΠΟΤΗΣΗ! Πρέπει να συναρμολογηθεί από ενήλικες. TR: UYARI! Yetişkinler tarafından takılmalıdır. SI: OPOZORIL! Postavitven izključno s strani odraslih oseb. HRV: UPOZORENJE! Postavljanje je dozvoljeno isključivo odraslim osobama. SK: UPOZORNENIE! Montovať smie len dospelá osoba. BG: ВНИМАНИЕ! Трябва да се монтира от възрастни лица. RO: AVERTISMENT! Trebuie montat de adulți. UA: УВАГА! Встановлюється дорослими. EST: HOIATUS! Paigaldama peavad täiskasvanud. LT: ĮSPĖJIMAS! Tik suaugusieji gali sumontuoti. LV: BRĪDINĀJUMS! Montāža jāveic pieaugušajiem. AR: تحذير! يتعين تجميعه من قبل أحد البالغين.

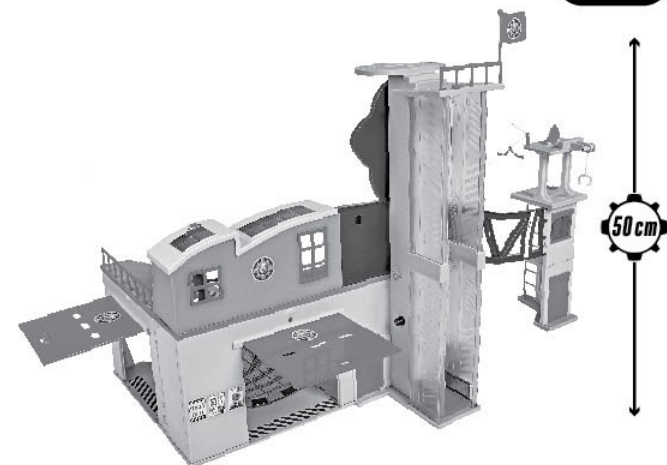

Simba Toys GmbH & Co. KG · Werkstr. 1 · 90765 Fürth · Germany

simbatoy.de | service.simbatoy.de

Simba Toys UK Ltd., Broomfield House, Bolling Road, Bradford BD4 7BG · Simba Toys España S.L., Edificio América II, C/ Proción, 7, Portal 2, Planta 2ª, Oficina E, 28023 Madrid · Simba Toys Italia s.r.l. - Strada Statale 32 n. 9 - 28050 Pombia (NO) Italy · Simba Toys Polska Sp. z o.o., ul. Flisa 2, 02-247 Warszawa · Simba Toys Hungária Kft., Vendel Park, Budai u. 4., 2051 Biatörbágy · Smoby Toys SAS., Le Bourg Desuss, 39170 Lavans-lès-Saint-Claude, France · Simba Toys CZ, spol. s r.o., Lidická 481, 273 51 Úhřetř · Simba Toys Bulgaria · Симва Тоис България ЕООД, с. Крушица 1588, общ. София, ул. Розова Градина 17, тел.+359 2 9625859 · Simba Toys Austria, Jochen-Rindt-Str. 25, 1230 Wien · Simba Oynacak Paz.Ltd. Şti. [çeremköy Mahallesi, Huzur Hoca Caddesi, Piramit Grup İş Merk. No.57 Kat 2, 34752 Ataşehir /İstanbul, TÜRKİYE · S.C. Simba Toys Romania SRL, Baneasa Business Center, Sos. Bucuresti-Ploiesti 19-21, Sector 1, 013694 · Bucuresti, Romania · Simba/Dickie (Switzerland) AG, Ausserfeldstrasse 9, 5036 Obereinfeld, Schweiz · Simba Toys Nordic As, Pindsløveien 1 C, 3221 Sandefjord, Norway · N.V. Simba Toys Benelux S.A., Moeskroensesteenweg 383C, B511 Aalbeke, Belgium · Simba Toys Middle East, P.O. Box 61106, Dubai, U.A.E. · Simba Dickie Finland Oy, Sinkkälöntie 3 B, 02630 Espoo, Finland · Simba Toys Ukraine Ltd., Симва Тоис Україна, вул. Червонокаменна 42, м. Київ 02660 · Simba Thailand 172 Moo 4, Soi Wat Prathah Bangkok-Patumthani Rd. Bangdua, Muang, Patumthani 12000 Thailand · SISO Toys South Africa (PTY) Ltd. Compass House, 12 Crassula Road, Cornubia, Durban, 4051 · Simba Toys Vietnam Limited, Floor 14-08B, Vincom building, Le Thanh Ton Street 72, Ben Nghe ward District 1, 70000 Ho Chi Minh City, Vietnam · Simba Toys India Pvt Ltd., 704 & 705, Meadows, Sahar Plaza Complex, J.B. Nagar, Andheri Kurla Road, Andheri East, Mumbai - 400059 · Fabricado en China / Hergestellt in China / Made in China / Fabricado en China / Fabricado en China / Fabricato in Cina 88881121

10 925 1059  
10 925 1059 038

