

MILITARY MINIATURES SERIES

CHINESE MEDIUM TANK
TYPE 59
EARLY PROD.

37026



GENERAL INSTRUCTION

- WORKABLE TORSION BARS
- ALL HATCHES CAN BE POSED OPEN
- CLEAR PARTS INCLUDED
- PHOTOETCHED PARTS INCLUDED
- DECAL SHEET FOR 6 VARIANTS



Chinese People's Liberation Army. Present time.
Народно-освободительная армия Китая, наше время.



Colors Chart

Таблица цветов

№	Color/Цвет	Value	Mt. Color	Life Color	Tamiya	Tenstar	AK Real Color	Hammer	Revell	Mixamo Models	Название цвета	Color name
01		70.904	136	SA-037	XF 62	1711	FC 078	156	365	MMP-036	Русский зеленый XB 516	Russian Green XB 516
02		70.916	119	SA-001	XF 59	1708	FC 003	250	116	MMP-039	Песочный	Sand Yellow
03		70.896	123	SA-116	XF 73	1671	FC 059	253	146	MMP-067	Темный зеленый	Dark Green
04		70.856	8	SA-008	XF 74	1591	FC 047	252	148	MMP-020	Оливково-зеленый	Olive Green
05		70.898	127	SA-240	XF 49	1734	FC 028	228	390	MMP-076	Светло-зеленый хаки	Light Green Khaki
06		70.893	76	LC-078	XI 54	1425	AK-434	27/004	191	MMB-001	Воронячий металл	Gun Metal
07		70.892	137	SA-783	XI 85	1763	FC 022	32	379	MMP-040	Черный	Tan Black
08		70.951	62	LC-001	XF 02	1786	FC 004	34	105	MMP-001	Белый	White
09		70.813	43	SA-714	XF 79	1735	FC 049	64	362	MMP-078	Деревяный	Wood
10		70.928	3	LC-008	XI 67	1503	AK-740	132	138	MMP-003	Красный	Red
11		70.871	115	SA-027	XI 25	4786	AK-2089	79	179	MMP-055	Сине-голубой	Blue Gray
12		70.810	41	LC-018	XI 64	1738	FC 067	100	104	MMP-012	Красно-коричневый	Red Brown
13		70.888	52	SA-063	XF 49	1712	FC-020	63	168	MMP-029	Темный хаки	Dark Khaki

Armed Forces of the Islamic Republic of Iran.
The Iran-Iraq war, early 80's.

Вооружённые силы Исламской республики Иран.
Ирано-иракская война, начало 80-х годов.



Kosovo Liberation Army, Albania border area
with Kosovo, April 1999.

Армия освобождения Косова.
Район границы Албании с Косово, апрель 1999 года.



ATTENTION

Ne pas utiliser de colle ou de peinture à proximité d'une flamme nue, et dans le plus de temps possible.
 Pour retirer les pièces hors du sac, utiliser des gants adaptés pour manipuler le plastique en évitant tout contact avec un outil ou une tige.
 Mettre le fin de cette colonne pour la signification des symboles.

ZUR BEACHTUNG

Kleber und Farbe nicht nahe von offenem Feuer verwenden und dies so schnell wie möglich tun.
 Zur Entfernung der Teile vom Verpackung eine Handschuhe verwenden und die überflüssigen Plastikteile mit einem Messer oder einer Feile beseitigen.
 Die Bedeutung der Symbole finden Sie unten in dieser Spalte.

AVVERTENZA

Non usare colla né vernice vicino a fiamme libere, né lavoro prolungato o prolungamento prolungato in aree ad alta temperatura.
 Dato che i componenti sono molto delicati, usare guanti adeguati per rimuovere le parti dal sacchetto.
 Eliminare i pezzi di plastica in eccesso con un coltello o una lima.
 Vedere la fine di questa colonna per il significato dei simboli.

ATTENZIONE

Non usare colle e vernice calientes e fiamme vivas y no trabajar prolongado o prolongado en zonas de alta temperatura.
 Cuando se retiren las partes del paquete, usar guantes adecuados y eliminar el exceso de plástico con un cuchillo o una lima.
 Verifique el fondo de esta columna por el significado de los símbolos.

ВНИМАНИЕ

При использовании клея и краски, не работайте продолжительно в непроветриваемых помещениях и в зоне с высокой температурой.
 Детали упаковки и сами детали очень легко повредить, используйте перчатки.
 Лишние детали и части пластика при помощи ножа или металлической пилы.
 Смотрите окончание этой колонки для значения символов.
 Для работы с клеем используйте защитные перчатки.

CAUTION

When you use glue or paint, do not use near open flame, and use in well-ventilated room.
 When you take parts off from the model frame, use a peeling pliers and trim excess plastic with a cutter or a file.
 See the bottom of this column for the meaning of symbols.

PARTS / ДЕТАЛИ**Ba****C****Ca****Hf x10****Ho x4****Hd x4**

Photo-etched parts
Детали фототравления

РБ (M-38)**Decals sheet | Декор****R****Hj****Hm x10**

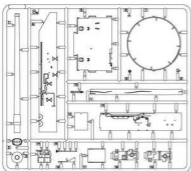
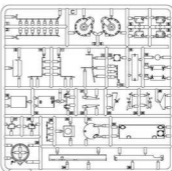
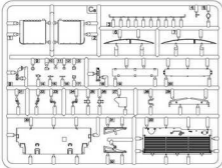
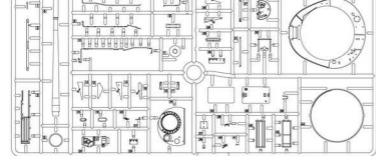

MAKES 2/2
2 TELLER FERTIGEN
STRECKEN FÜR 2 THEILE
FARE DUE PZED
TEL 2/2
DOK 2/2
POBYPATY DVA PZED
KILASZKI PZED

DO NOT ASSEMBLE
NICH NE SLOZHEN
NOM NE SLOZHEN
ELIMINARE
LIMINARU
NE POBYPATY VPER
NE KESTEN

OPTIONAL
NAZHOBJEMEN
FAKUL SATOR
FACULTATIVO
SILKIMMANNANEN
SILKAR
BARKANTU
BARKANTI

OPEN HOLE
OTKRYT
LAME OLY TRZNY
POMI OPIWU
OPRYM HALET
ODKRYTA OTRWY
ZROBITA OTWR

REMOVE
ENTFERNEN
SITHEIN
SERRAME
ROZBIRAC
AVLADAN
OTRYWAC
SODRACAT

BEAD
BITE BEZEN
KLEBTE, VOUS PLANT
PILGARE
BETA
ROCKA
VYKLEP
VYKUPIT

SCRATCHES
AM MEISTEN ZU MACHEN
FANGLE FLECK
WEGHOLT
TEUFEL
DOA (NE) ALJAVY
CZESTO GABNAMY
ZROBITA SAKRATY

PARTS NOT FOR USE
TEILE WERDEN NICHT VERWENDET
WSTI PZED UPOLZE
PARTY NICH PZED
CZESTO GABNAMY
WSTI FOR AWASBANDING
NE POBYPATY VPER
NE BROPKOPBYSTVEN

PARTS / DETALN

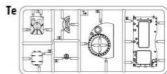
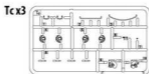
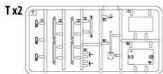
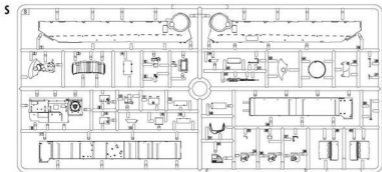
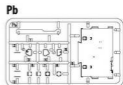
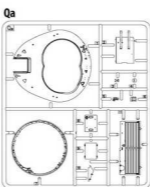
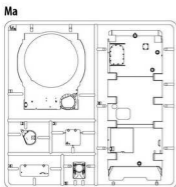
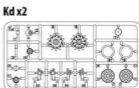
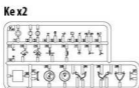
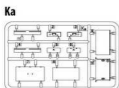

1

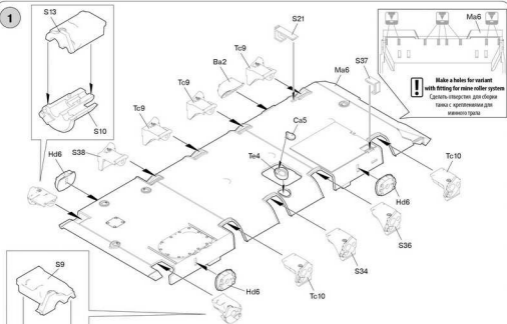

2

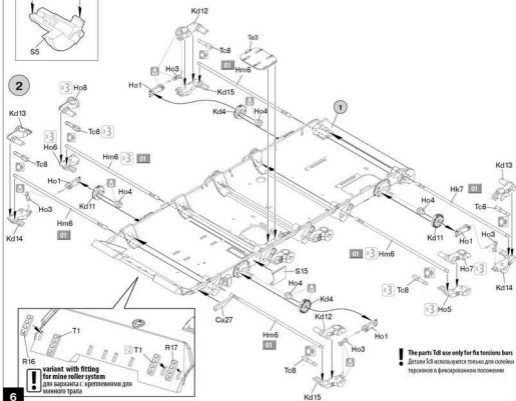

6

3

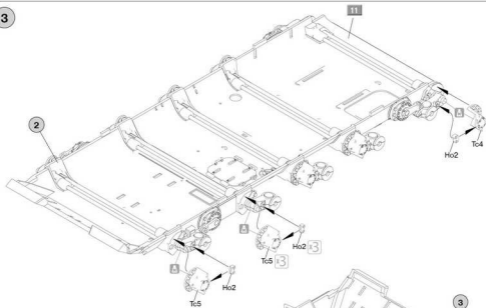

4

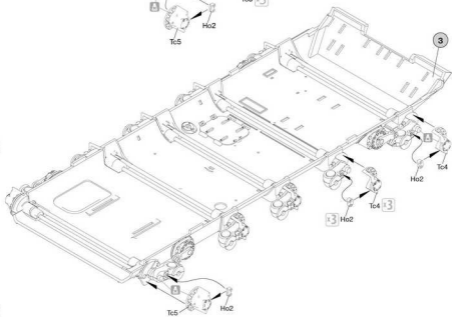

5

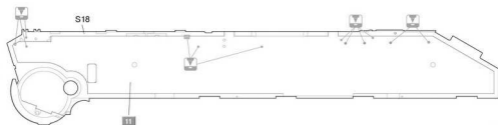

6

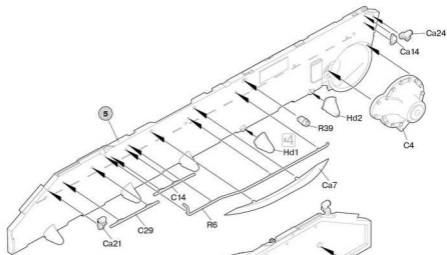

7

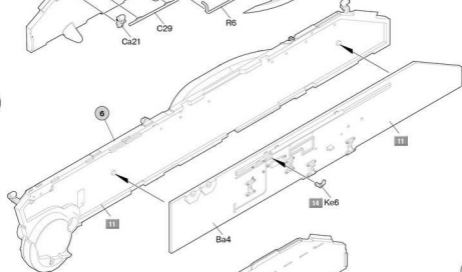

8

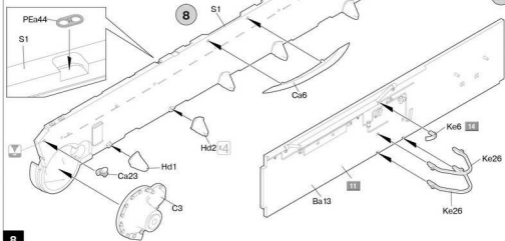

9

8

10

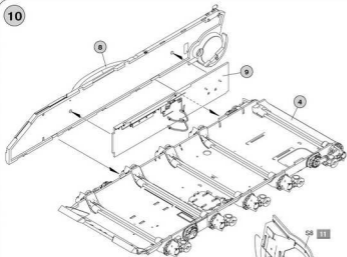

11

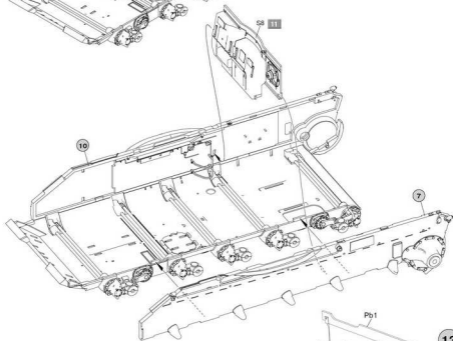

12

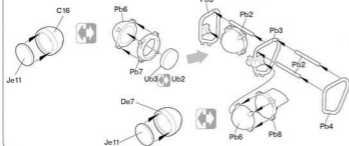

13

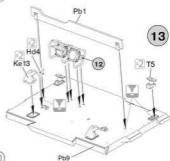

! The parts T5 use for variant with fitting for mine roller system
 Детали T5 используются для варианта с креплением для млиного траля

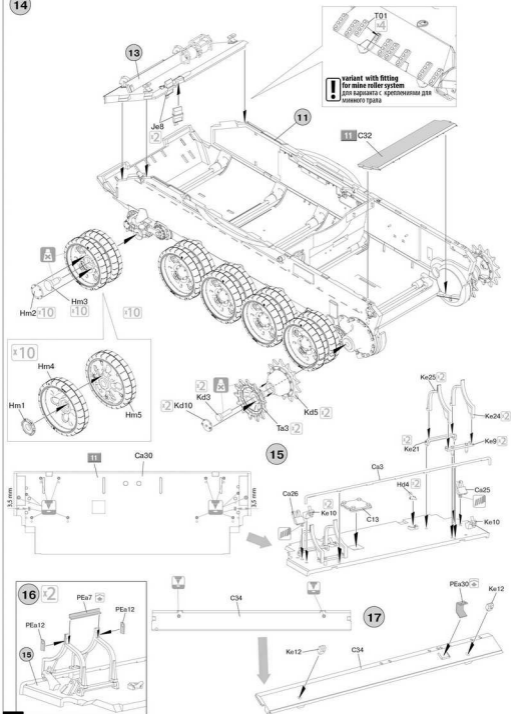

18

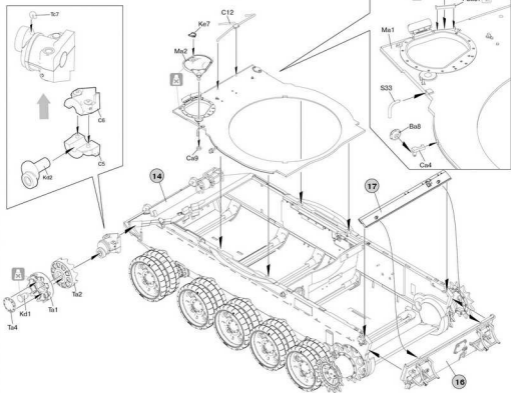

19

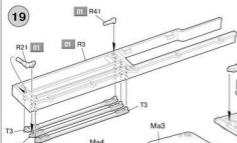

20

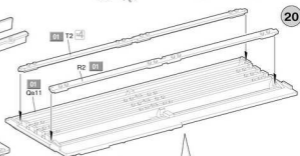

21

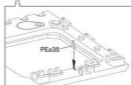
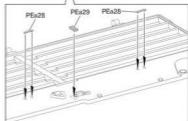
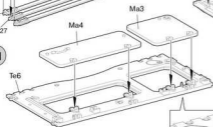

11

22

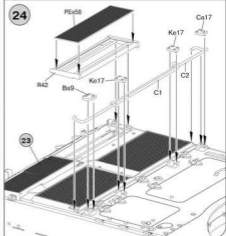
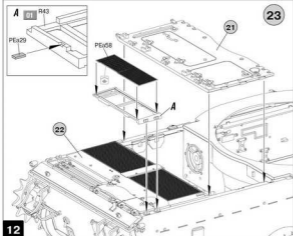
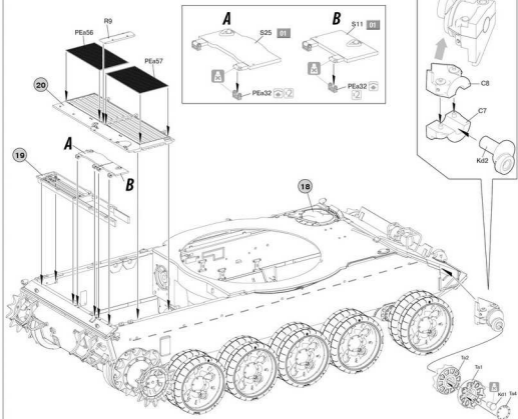

12

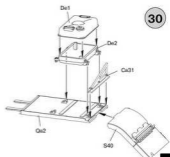
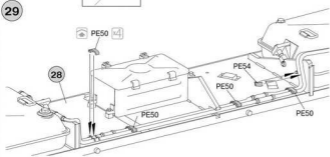
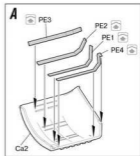
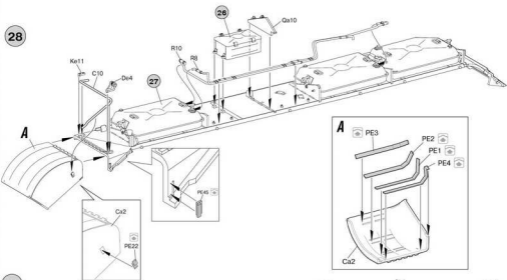
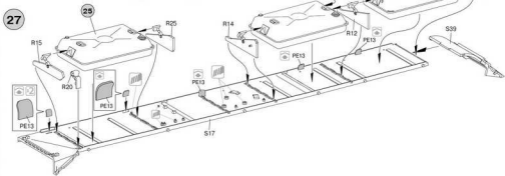
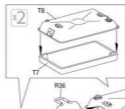
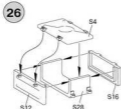

31

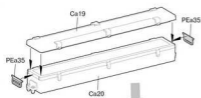
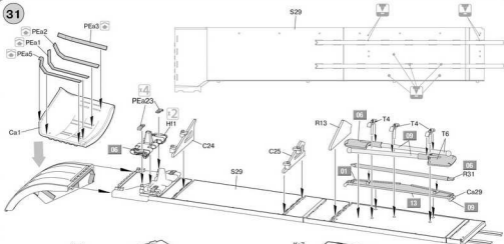

32

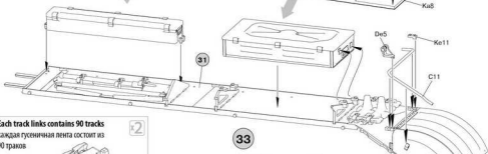

Each track link contains 90 tracks
каждая гусеничная лента состоит из
90 траков

2

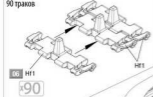

33

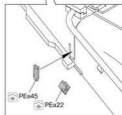
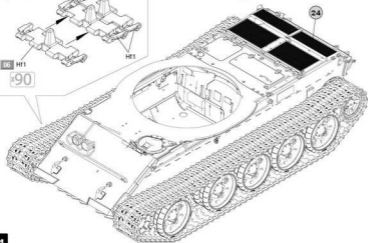

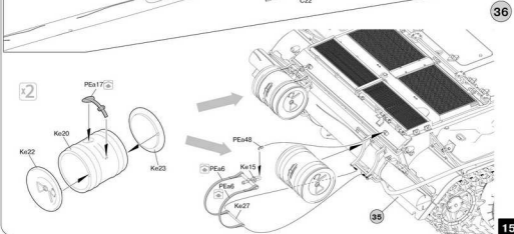
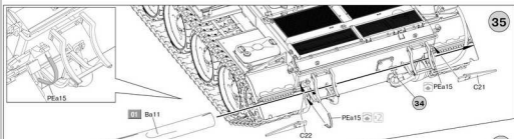
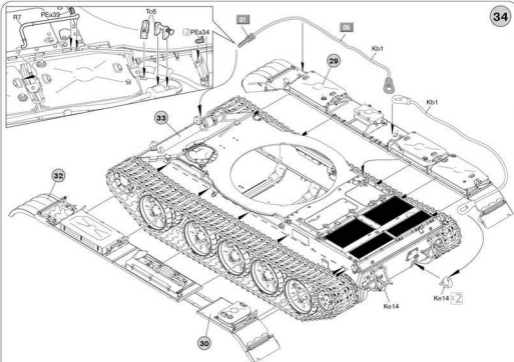

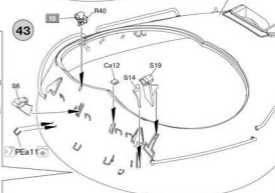
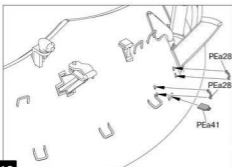
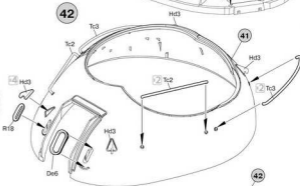
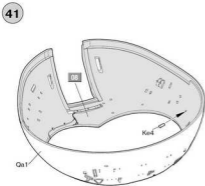
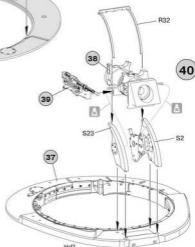
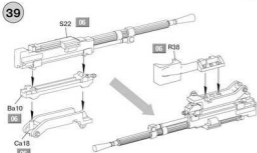
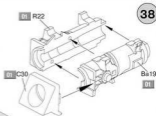
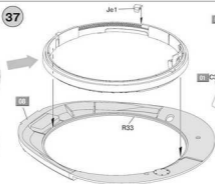
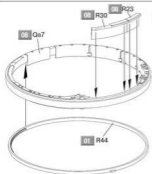

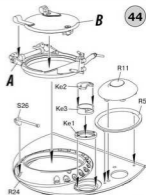
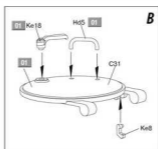
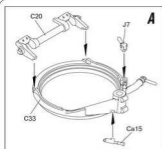

45

46

44

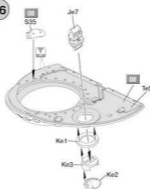
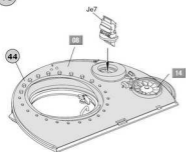

47

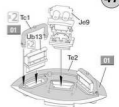

48

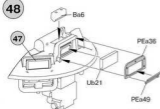

49

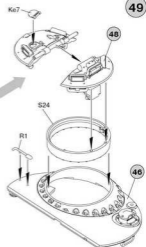
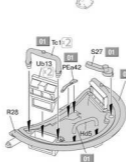
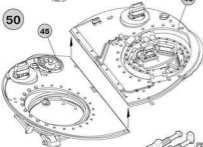

51

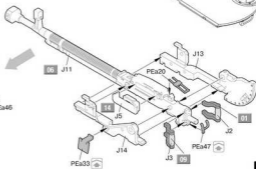
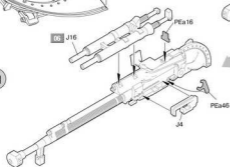

17

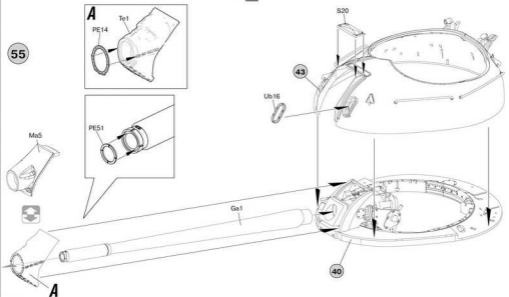
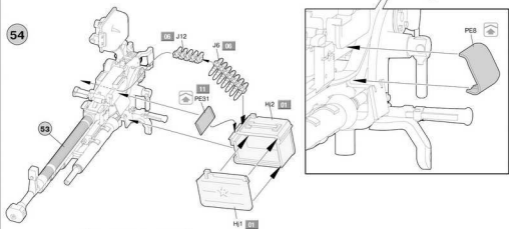
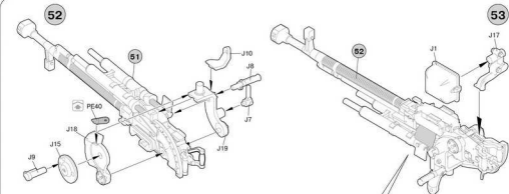

56

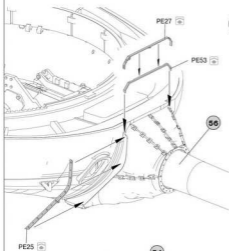
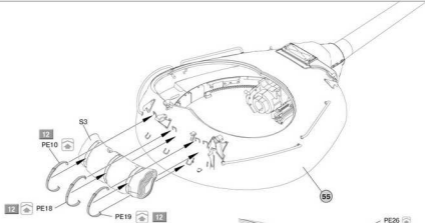

57

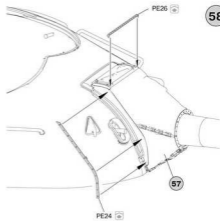

58

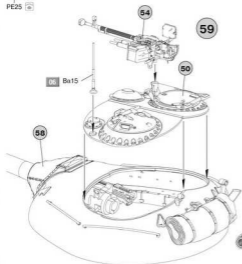

59

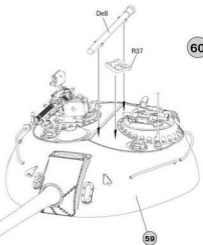

60

61

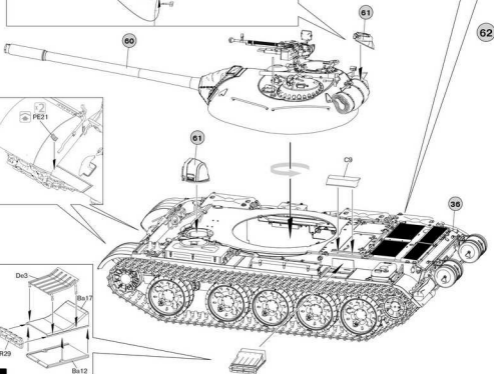
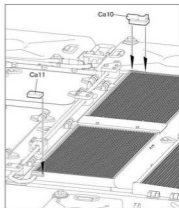
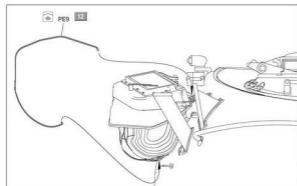
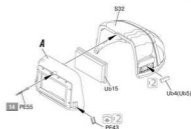
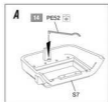

20



MiniArt

37026

TYPE 59
EARLY PROD

Chinese People's Liberation Army.
Present time

Народно-освободительная армия Китая,
наше время.



Chinese People's Liberation Army.
Present time

Народно-освободительная армия Китая,
наше время.



201st Tank Regiment Viet Cong,
17th parallel, March 1972.



201-й танковый полк Национального фронта
освобождения Южного Вьетнама,
17-я параллель, март 1972 года.



108th Tank Regiment 43rd Army Corps
of the Chinese People's Liberation Army.
Sino-Vietnamese War,
February 1979.



108-й танковый полк 43-го армейского корпуса
НОАК. Китайско-вьетнамская война,
Февраль 1979-го года.

