

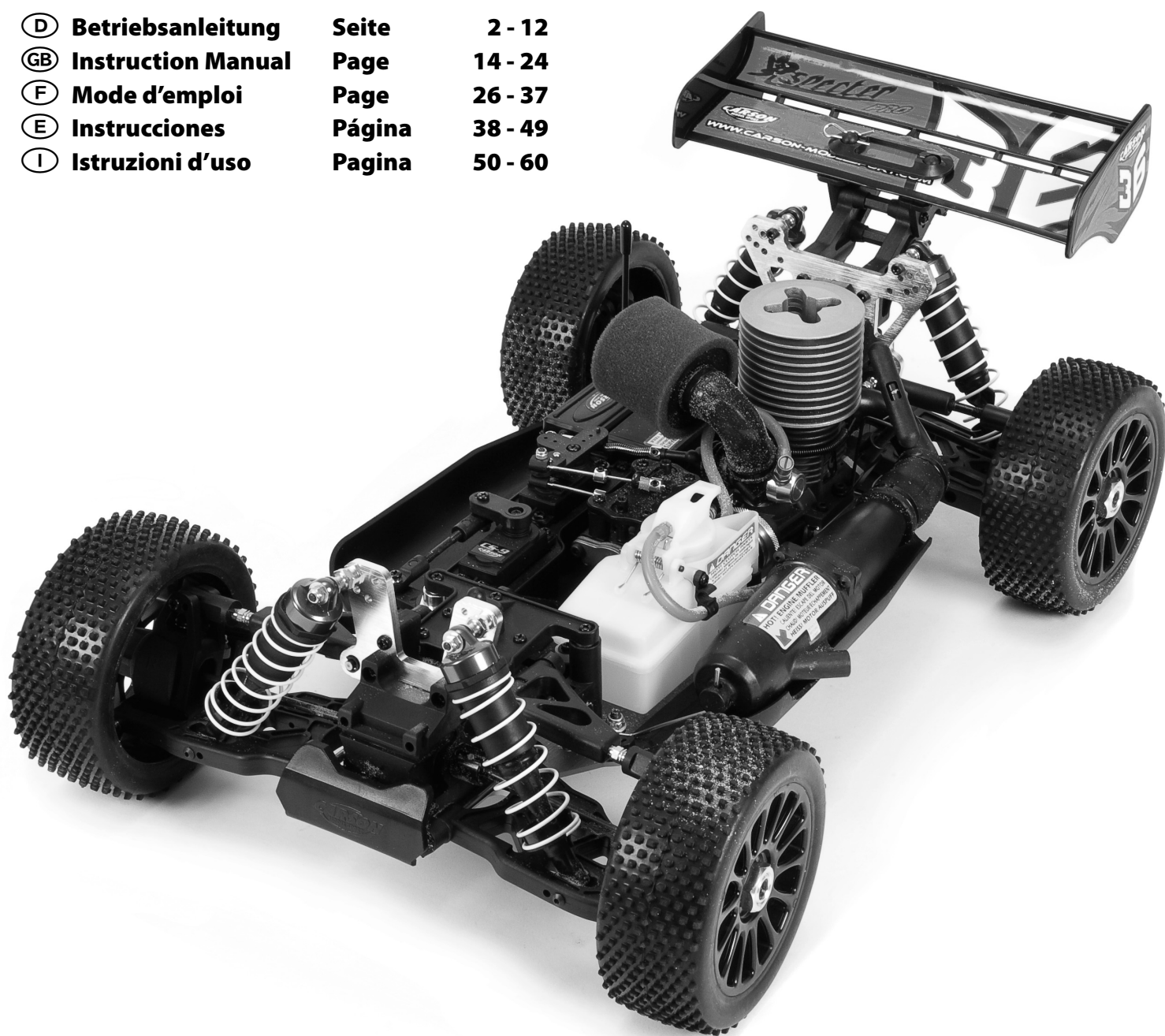

CY Pro Chassis

www.carson-modelsport.com

Ⓓ	Betriebsanleitung	Seite	2 - 12
ⒼⒷ	Instruction Manual	Page	14 - 24
Ⓕ	Mode d'emploi	Page	26 - 37
Ⓔ	Instrucciones	Página	38 - 49
Ⓘ	Istruzioni d'uso	Pagina	50 - 60



Sehr geehrter Kunde

Wir beglückwünschen Sie zum Kauf Ihres CARSON RC-Modellautos, das nach dem heutigen Stand der Technik gefertigt wurde.

Da wir stets um Weiterentwicklung und Verbesserung unserer Produkte bemüht sind, behalten wir uns eine Änderung in technischer Hinsicht und in Bezug auf Ausstattung, Materialien und Design jederzeit und ohne Ankündigung vor.

Aus geringfügigen Abweichungen des Ihnen vorliegenden Produktes gegenüber Daten und Abbildungen dieser Anleitung können daher keinerlei Ansprüche abgeleitet werden.

Diese Bedienungs- und Montageanleitung ist Bestandteil des Produkts. Bei Nichtbeachtung der Bedienungsanleitung und der enthaltenen Sicherheitsanweisungen erlischt der Garantieanspruch.

Bewahren Sie diese Anleitung zum Nachlesen und für die eventuelle Weitergabe des Modells an Dritte auf.

Garantiebedingungen

Für dieses Produkt leistet CARSON eine Garantie von 24 Monaten betreffend Fehler bei der Herstellung in Bezug auf Material und Fertigung bei normalem Gebrauch ab dem Kauf beim autorisierten Fachhändler. Im Falle eines Defekts während der Garantiezeit bringen Sie das Modell zusammen mit dem Kaufbeleg zu Ihrem Fachhändler.

CARSON wird nach eigener Entscheidung, falls nicht anders im Gesetz vorgesehen:

- Den Defekt durch Reparatur kostenlos in Bezug auf Material und Arbeit beheben;
- Das Produkt durch ein gleichartiges oder im Aufbau ähnliches ersetzen; oder
- Den Kaufpreis erstatten.

Alle ersetzten Teile und Produkte, für die Ersatz geleistet wird, werden zum Eigentum von CARSON. Im Rahmen der Garantieleistungen dürfen neue oder wiederaufbereitete Teile verwendet werden.

Auf reparierte oder ersetzte Teile gilt eine Garantie für die Restlaufzeit der ursprünglichen Garantiefrist. Nach Ablauf der Garantiefrist vorgenommene Reparaturen oder gelieferte Ersatzteile werden in Rechnung gestellt.

Von der Garantie ausgeschlossen sind:

- Beschädigung oder Ausfall durch Nichtbeachten der Sicherheitsanweisungen oder der Bedienungsanleitung, höhere Gewalt, Unfall, fehlerhafte oder außergewöhnliche Beanspruchung, fehlerhafte Handhabung, eigenmächtige Veränderungen, Blitzschlag oder anderer Einfluss von Hochspannung oder Strom.
- Schäden, die durch den Verlust der Kontrolle über Ihr Fahrzeug entstehen.
- Reparaturen, die nicht durch einen autorisierten CARSON Service durchgeführt wurden
- Verschleißteile wie etwa Sicherungen und Batterien
- Rein optische Beeinträchtigungen
- Transport-, Versand- oder Versicherungskosten
- Kosten für die Entsorgung des Produkts sowie Einrichten und vom Service vorgenommene Einstell- und Wiedereinrichtungsarbeiten.

Durch diese Garantie erhalten Sie spezielle Rechte, darüber hinaus ist auch eine von Land zu Land verschiedene Geltendmachung anderer Ansprüche denkbar.

Konformitätserklärung

Hiermit erklärt CARSON Modelsport, dass sich dieses Modell einschließlich Fernsteueranlage in Übereinstimmung mit den grundlegenden Anforderungen folgender EG-Richtlinien: 98/37EG für Maschinen und 89/336/EWG über die elektromagnetische Verträglichkeit und den anderen relevanten Vorschriften der Richtlinie 1999/5/EG (R&TTE) befindet.

Die Original-Konformitätserklärung kann angefordert werden.



Bedeutung des Symbols auf dem Produkt, der Verpackung oder Gebrauchsanleitung: Elektrogeräte sind Wertstoffe und gehören am Ende der Laufzeit nicht in den Hausmüll! Helfen Sie uns bei Umweltschutz und Recourcenschonung und geben Sie dieses Gerät bei den entsprechenden Rücknahmestellen ab. Fragen dazu beantwortet Ihnen die für Abfallbeseitigung zuständige Organisation oder Ihr Fachhändler.

Wir wünschen Ihnen viel Spaß mit Ihrem CARSON Modellauto und jederzeit gute Fahrt!

Vor dem Gebrauch Ihres neuen Modells lesen Sie bitte dieses Handbuch sorgfältig durch!

Inhalt

- Vorwort 2
- Lieferumfang..... 3
- Sicherheitsanweisungen 4
- Zum Betreiben des Motors erforderliches Zubehör 5
- Für den Zusammenbau erforderliches Werkzeug 6
- a. Ihre Fernsteuerung 6
- b. Chassis..... 7
- c. Einlegen der Empfängerbatterien 7
- d. Funktionstest 8
- e. Letzte Vorbereitungen..... 8
- f. Es kann losgehen... fast 9
- g. Einschalten der RC-Anlage..... 10
- h. Steuern des Modells..... 10
- i. Wartung und Pflege 11
- j. Problembehandlung..... 12
- Montageanleitung..... 61
- Schrauben 81
- Ersatzteile 82
- Tuningteile..... 87
- 3,5 cm³ Motor..... 89
- Force 25R – 4,01 cm³ Motor..... 91
- Force 32 – 5,23 cm³ Motor..... 93
- Setup Sheet 95

D

Lieferumfang



Sender
(Nur in der RTR Version
enthalten)

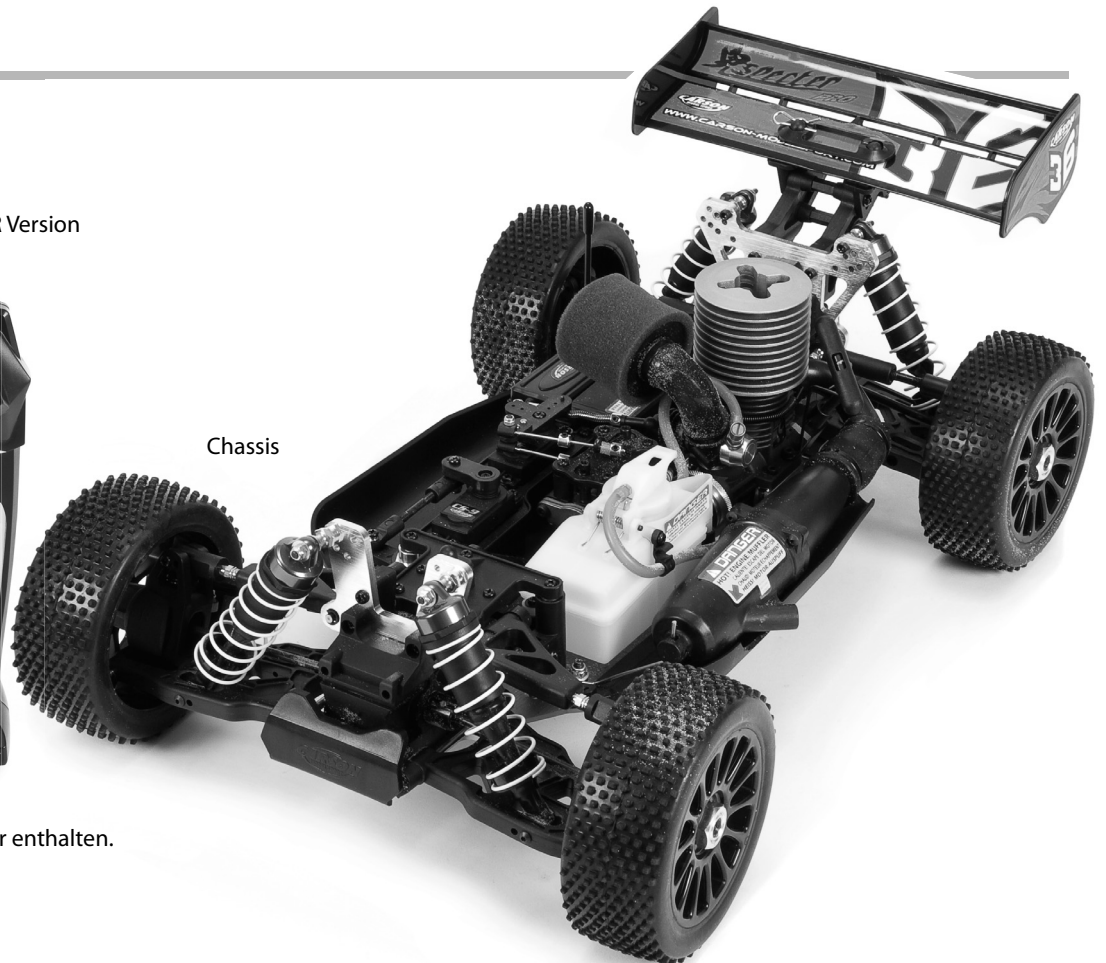

Chassis

Bei Kit-Version kein RC und kein Motor enthalten.

D **Sicherheitsanweisungen**

Sicherheitsanweisung und bestimmungsgemäße Verwendung

Ein Verbrenner-RC-Modellauto ist ein ferngesteuertes, mit speziellem Modellkraftstoff betriebenes Modellauto. Es ist ausschließlich für Hobbyzwecke ausgelegt und darf nur auf dafür vorgesehenen Bahnen und Plätzen, nicht in geschlossenen Räumen gefahren werden.

Mit einem Verbrenner-RC-Modellauto dürfen keine Güter, Personen oder Tiere transportiert werden.

Um Bedienungsfehler zu vermeiden, muss vor der Benutzung unbedingt die Gebrauchsanweisung gelesen werden!

Modellautos dürfen nur mit einer Karosserie, die ordnungsgemäß angebracht ist, betrieben werden.

Vor dem Abnehmen der Karosserie den Motor abkühlen lassen, da Kühlkopf und Auspuff im Betrieb heiß werden.

Das Modell darf nicht dauerhaft in unmittelbarer Nähe von Personen betrieben werden, da unter Umständen Gehörschäden auftreten können.

Um zu vermeiden, dass das Modell mit Störungen im Steuerungssystem und dadurch unkontrolliert fährt, sind die Batterien des Senders und des Empfängers auf einwandfreien Ladezustand hin zu überprüfen.

Die korrekte Montage der Modellautos muss stets vor und nach jeder Fahrt überprüft werden, gegebenenfalls Schrauben und Muttern nachziehen.

Die Tankanlage muss vor jedem Gebrauch auf Dichtheit geprüft werden. Der Tankdeckel muss stets dicht verschlossen sein.

Dieses Modell ist kein Spielzeug!

- Funkferngesteuerte Modelle sind kein Spielzeug, Ihre Bedienung muss schrittweise erlernt werden.
- Kinder unter 14 Jahren sollten das Modell nur unter Aufsicht von Erwachsenen in Betrieb nehmen.

Das Fahren von ferngesteuerten Autos ist ein faszinierendes Hobby, das jedoch mit der nötigen Vorsicht und Rücksichtnahme betrieben werden muss. Ein ferngesteuertes Modellauto, das ein beachtliches Gewicht aufweist und eine sehr hohe Geschwindigkeit erreicht, kann in einem unkontrollierten Fahrzustand erhebliche Beschädigungen und Verletzungen verursachen, für die Sie als Betreiber haftbar sind.

Vergewissern Sie sich bei Ihrer Versicherung, ob Sie beim Ausüben Ihres Hobbys versichert sind. Nur ein einwandfrei zusammengebautes Modell wird erwartungsgemäß funktionieren und reagieren.

Improvisieren Sie niemals mit untauglichen Hilfsmitteln, sondern verwenden Sie im Bedarfsfall nur Originalersatzteile. Auch bei einem vormontierten Modell sollten Sie alle Verbindungen auf exakten und festen Sitz kontrollieren.

Fahren Sie niemals, ohne sich von den folgenden Punkten überzeugt zu haben:

- Empfängerakku und Senderakku müssen vollständig geladen sein.
- Überprüfen Sie vor dem Start die Funkreichweite.
- Überprüfen Sie das ordnungsgemäße Ansprechen der Servos auf die Steuersignale.
- Alle Funktionsteile des Fahrzeugs sind in einwandfreiem Zustand und überprüft.
- Sämtliche Schrauben sind auf festen Sitz überprüft.
- Es ist kein RC- oder anderer Sender in der Nähe in Betrieb, der Funkstörungen verursachen könnte. Störsignale auf gleicher Frequenz können bewirken, dass Sie die Kontrolle über Ihr Modell verlieren. Schalten Sie immer zuerst den Sender ein, um zu vermeiden, dass der Empfänger unkontrolliert auf ein fremdes Funksignal reagiert.
- Ziehen Sie die Senderantenne immer vollständig heraus. Bei gleichzeitigem Betrieb mehrerer Fahrzeuge darf das Modell nur auf einer freien Frequenz betrieben werden. Schalten Sie nach Beendigung des Fahrbetriebes zuerst den Empfänger, dann den Sender aus.
- Fahren Sie auch nicht unter Hochspannungsleitungen oder Funkmasten oder bei Gewitter!
- Atmosphärische Störungen können die Signale Ihres Fernsenders beeinflussen.
- Die Elektrik des Modells ist nicht wasserdicht. Fahren Sie deshalb nicht bei Regen, Schnee, durch Pfützen oder nasses Gras.
- Das ferngesteuerte Modell darf nur auf geeignetem Gelände und nicht auf öffentlichen Verkehrsflächen betrieben werden.
- Nicht in der Nähe von Personen und Tieren fahren!
- Fahren Sie nicht, wenn sie übermüdet oder anderweitig in Ihrer Reaktionsfähigkeit beeinträchtigt sind.
- Halten Sie immer direkten Sichtkontakt zum Modell.
- Fahren Sie das Modell nur mit ordnungsgemäß angebrachter Karosserie.
- Regelmäßige Wartung und Pflege ist für erstklassige Fahrleistung notwendig.
- Das Modell hat Teile, die sich im Betrieb erhitzen, z.B. die Oberseite des Motors, die Abgasanlage, das Metallgetriebe und vieles mehr. Die Berührung dieser Teile während des Betriebs kann zu Verletzungen führen.

Achten Sie auf Ladezustandsanzeige Ihres Senders.

- Mit halbleeren Akkus können Sie die Kontrolle über das Modell verlieren.
- Mischen Sie im Sender niemals volle Akkus / Batterien mit halbleeren oder Akkus unterschiedlicher Kapazität.
- Versuchen Sie nie, Trockenbatterien zu laden (nur Akkus sind aufladbar).

Bei längerem Nichtgebrauch ist der Empfängerakku unbedingt zu entfernen.

Bezüglich des Kraftstoffes bitte folgendes beachten:

- Unter Verschluss und für Kinder und Tiere unzugänglich aufbewahren
- Behälter dicht geschlossen halten
- Behälter an einem gut belüfteten Ort aufbewahren
- Von Zündquellen fernhalten – Nicht rauchen
- Nicht verschlucken und Berührung mit der Haut vermeiden

Kraftstoffreste und -behälter müssen als Sondermüll beseitigt werden.

Bei Unfall oder Unwohlsein sofort den Arzt hinzuziehen (wenn möglich das Etikett des Kraftstoffs vorzeigen).

Zum Schluss

Bitte lesen Sie diese Betriebsanleitung sorgfältig durch, bevor Sie irgendwelche Arbeiten beginnen.

Nach jeder Fahrt sollten Sie die wichtigsten Bauteile und Verbindungen überprüfen. Eine einzige gelockerte Schraube kann ausreichen, um Ihr Modell in eine gefährliche Situation geraten zu lassen! Warten Sie Ihr Modell regelmäßig und wechseln Sie defekte oder abgenutzte Bauteile gegen Original-Ersatzteile aus.

Wir wünschen Ihnen viel Spaß mit Ihrem CARSON-Modellauto und jederzeit gute Fahrt!

Zum Betreiben des Motors erforderliches Zubehör

Glühkerzenstecker
50 090 5042



Afterrunöl
50 090 5044



Luftfilteröl
50 003 2648



Kraftstoff-
füllflasche
50 001 3330



Kraftstoff

Nitroset
50 090 5072



CARSON-Kraftstoffe werden empfohlen

Liter	Nitromethan	N°	Verwendung
1,0	10%	50 090 5052	Einlaufen/ Beginner
1,0	16%	50 090 5053	Normal
2,5	16%	50 090 5054	Normal
1,0	25%	50 090 5055	Race
2,5	25%	50 090 5056	Race

CARSON-ROSSI Glühkerzen

N°	Bezeichnung	Motorart	Kraftstoffart	Temperatur
50 090 5006	Glühkerze Rossi R2 heiß	2 - 3,5 ccm	ohne Nitro	+0° - +15°C
50 090 5007	Glühkerze Rossi R3 medium	3,5 - 6 ccm	ohne Nitro	-2° - +18°C
50 090 5008	Glühkerze Rossi R4 kalt	6 - 10 ccm	ohne Nitro	-5° - +20°C
50 090 5009	Glühkerze Rossi R5 extra	3,5 - 10 ccm	10% Nitro	-7° - +22°
50 090 5010	Glühkerze Rossi R6 kalt	universal	10-13% Nitro	+10° - +25°
50 090 5011	Glühkerze Rossi R7 kalt	universal	13-15% Nitro	+15° - +30°
50 090 5012	Glühkerze Rossi R8 extra kalt	universal	13-15% Nitro	+20° - +40°



Für den Sender werden 8 Stück AA Batterien/Akkus benötigt.

D Für den Zusammenbau erforderliches Werkzeug

Modellbaumesser 30 007 4053

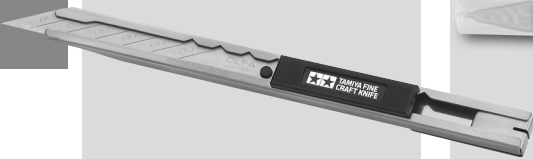

Sekundenkleber 30 005 3339



Spitzzange 30 007 4034



Schere 30 001 3305



Kreuzschlitz-Schraubendreher
(klein und groß) und Inbusschlüssel
1,5/2/2,5 mm 30 007 4023

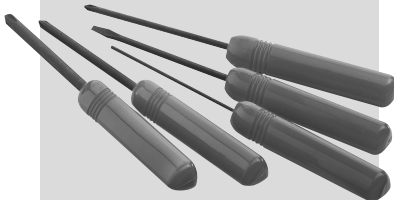

Kreuzschlüssel 30 001 3118



Pinzette 30 007 4003



Seitenschneider 30 007 4035

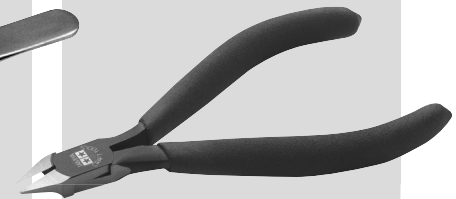

a. Ihre Fernsteuerung (nur bei RTR-Version)

Bitte lesen Sie die, Ihrem RC-System beiliegende Anleitung, genau durch.

Vor dem Einbau müssen die Servos in Mittelstellung gebracht werden. Dazu schalten Sie bitte den betriebsbereiten Sender und Empfänger ein. Stellen Sie die Trimmhebel am Sender auf Mittelstellung. Jetzt schalten Sie den Empfänger und dann den Sender aus. Die Servos sind jetzt für den Einbau genau auf Neutralstellung.

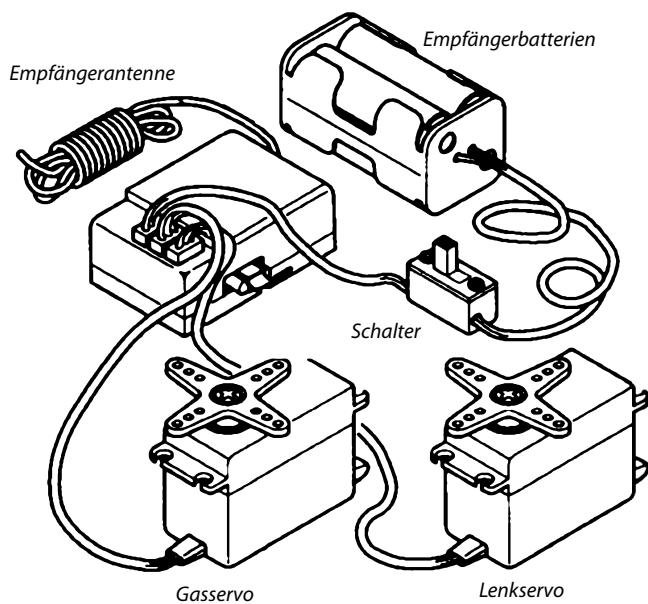

b. Chassis

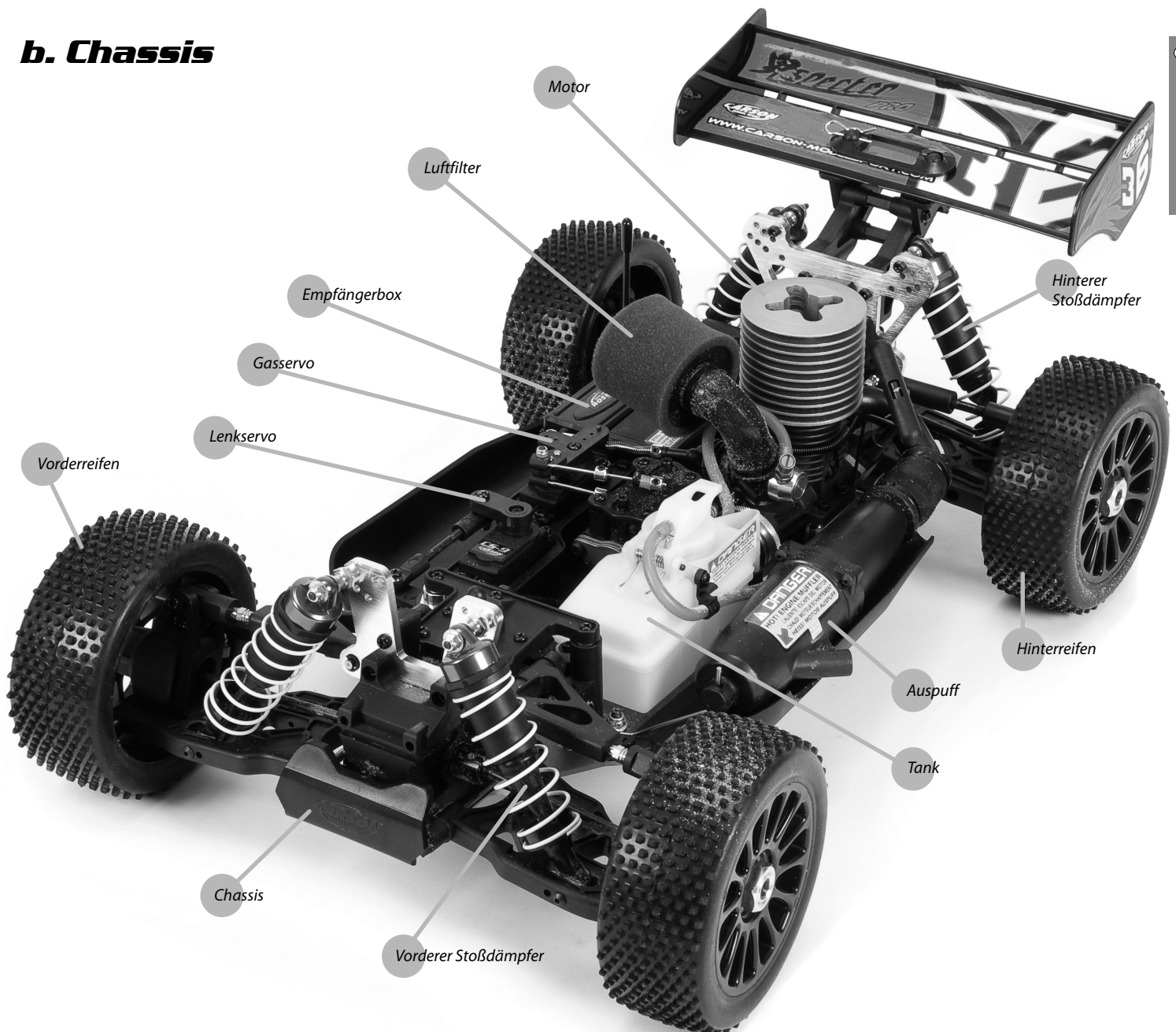

c. Einlegen der Empfängerbatterien

Legen Sie vier „AA“ Batterien in die Batteriehalterung des Empfängers ein (siehe Bild 1). Achten Sie auf die korrekte Polung. Verbinden Sie dann den Akku mit dem zugehörigen Stecker zum Empfänger. Schwarz muss mit schwarz und rot mit rot verbunden werden. Schließen Sie dann das Batteriefach mit der zugehörigen Abdeckung.

Insider Tipp:

Benutzen Sie wiederaufladbare Batterien. Diese halten länger und sind auf längere Sicht gesehen billiger. Ersetzen Sie die vier „AA“ Batterien durch unseren NiMh 6 V/ 1100 mAh Akkupack (N° 50 060 8036 JR).

Bild 1



D d. Funktionstest

Schalten Sie immer zuerst die Fernbedienung ein, bevor Sie Ihr Auto einschalten. Nun können Sie Ihr Auto einschalten, indem Sie den EIN/AUS-Schalter am Auto betätigen. Hinweis: Überprüfen Sie immer die Einstellung Ihrer Fernbedienung, vor der Benutzung Ihres Autos.

Überprüfen Sie bitte, ob die Lenkung zentriert ist. Sollte dies nicht der Fall sein, benutzen Sie den ST-Trim-Knopf links neben dem Lenkrad. Die Drehung nach links sollte das Auto nach links fahren lassen, eine Rechtsdrehung nach rechts.

Nun muss der Vergaser in die Neutralstellung gebracht werden. Entfernen Sie den Luftfilter vom Vergaser.

Im Vergaserhals muß ein Spalt von ca. 1 - 1,5 mm zu sehen sein (siehe Bild 2). Sollte der Spalt größer sein, kann es sein, dass der Motor mit zu hoher Drehzahl läuft. Dies kann dazu führen, dass die Bremsen und/ oder die Kupplungsbeläge vorzeitig abgenutzt werden und es erschwert das Fahren des Autos.

Benutzen Sie den TH-Trim (siehe Bild 3) um den Servoarm, wenn nötig, in die neutrale Position zu bringen. In der Neutralposition sollten die Bremsen nicht schleifen. Die Einstellung erfolgt mit einem 1,5 mm - Inbusschlüssel über einen Stellring am Bremsgestänge. Wenn Sie mit den Einstellungen zufrieden sind, bringen Sie den Luftfilter wieder an.



e. Letzte Vorbereitungen...

Stecken Sie die Kraftstoff-Flasche zusammen. Drücken Sie diese zusammen und stecken Sie die Spitze in einen Kanister mit Nitro Auto-Kraftstoff. Lassen Sie langsam mit dem Druck nach und die Flasche füllt sich von selbst. Danach, drücken Sie langsam die Flasche zusammen um den Benzintank Ihres Autos aufzufüllen.

Insider Tipp 1:

Der Kraftstoff hält sich länger, wenn Sie diesen an einem kalten, dunklen und trockenen Platz aufbewahren.

Insider Tipp 2:

Lassen Sie den Glühkerzenstecker niemals länger als 10 Sekunden am Motor angeschlossen. Wenn Sie diesen zu lange benutzen, kann dies dazu führen, dass die Glühkerze vorzeitig durchbrennt. Benutzen Sie wiederaufladbare Glühzylinder für längere Lebensdauer.

Insider Tipp 3:

Zum Starten feuerfeste Handschuhe anziehen!

f. Es kann losgehen... fast!

Das Einfahren des Motors ist der wichtigste Schritt, um sicherzugehen, dass Ihr Motor immer schnell und verlässlich läuft. Einfach gesagt: LASSEN SIE DIESEN TEIL NICHT AUS!

Der Motor ist vom Hersteller schon „Voreingestellt“. Benutzen Sie „FAT BONE“ 50 090 5034 oder eine andere Plattform und stellen Sie das Auto so darauf, dass die Reifen keinen Bodenkontakt haben und sich frei bewegen können.

Der Gashebel der Fernsteuerung muss in der Position „neutral“ sein. Platzieren Sie den Glühkerzenstecker auf der Glühkerze und ziehen Sie das Startseil kräftig heraus (siehe Bild 4). Es darf jedoch nicht mehr als 25 cm herausgezogen werden! Wenn Sie es weiter herausziehen, kann das Seil reißen. Es ist besser, das Startseil kurz und kräftig zu ziehen, als zu weit heraus. Sollte das Startseil hängen bleiben, rotieren Sie bitte das Schwungrad etwas mit Ihrem Finger. Das sollte das Seil automatisch wieder in die Startposition bringen. Nach einigen Zügen, sollte der Motor mit viel Rauch starten.



Sollte der Motor Probleme im Leerlauf haben, drehen Sie bitte die Schraube für den Leerlauf im Uhrzeigersinn immer um 1/8 Schritte weiter. Das erhöht den Leerlauf, was ein korrektes Einfahren des Motors ermöglicht. Führen Sie diesen Vorgang nur in einem gut durchlüfteten Raum durch, vorzugsweise im Freien, z.B. Ihrer Einfahrt. Nicht verbranntes Öl des Kraftstoffes kann sich am Auspuff sammeln, legen Sie etwas unter. Lassen Sie das Auto im Leerlauf über 2 bis 3 Tankfüllungen laufen und überprüfen Sie die Temperatur des Motors etwa alle zwei Minuten. Lassen Sie zwischen den Tankfüllungen 10 - 15 Min Pause zum Abkühlen. Der Motorkühlkörper sollte mit dem Finger berührt werden können und nicht zu heiß sein. (ACHTUNG! Nicht anfassen!) Sollte die Oberfläche zu heiß werden, erhöhen (drehen gegen den Uhrzeigersinn) Sie die Hauptdüsennadel um 1/8. Gehen Sie in kleinen Schritten vor, wenn Sie solche Veränderungen vornehmen.

Tipp:

Werkseinstellung vom Vergaser:

Mit folgender Grundeinstellung springt der Motor sofort an und läuft sauber und ausreichend fett (Außentemperatur 8°C)

- Leerlaufschraube: ca. 1 mm Luftspalt;
- Hauptdüsennadel: ganz schließen, dann 4 Umdrehungen öffnen;
- Gemisch-Schraube (Anlenkung): mit dem Rand des Lenkhebels bündig, dann 1 Umdrehung schließen.

Sobald der Einfahrprozess abgeschlossen ist, muss die Hauptdüsennadel mindestens 3 1/4 Umdrehungen geöffnet sein. Bei hohen Außentemperaturen wird es nötig sein, die Einstellungen etwas fetter zu wählen.

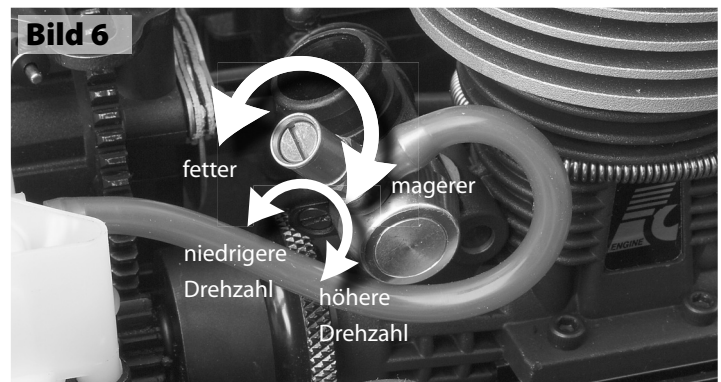
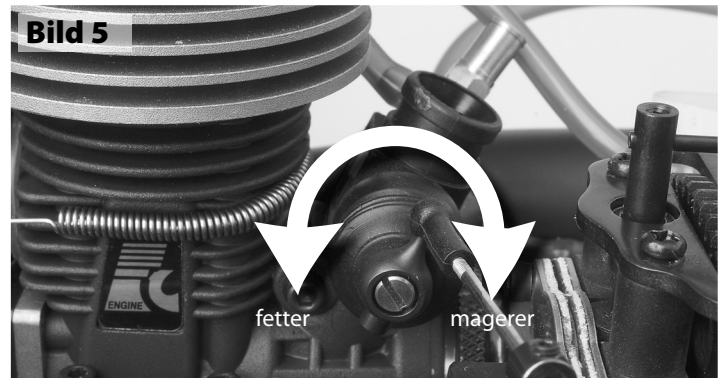

Insider Tipp:

Nach der Einlauf-Periode können Sie Ihr Auto bei fetter Vergaser-Einstellung langsam fahren und vermeiden Sie längere Zeiten bei Vollgas. Stimmen Sie die Einstellung mit 1/8 Drehungen vorsichtig ab. Der Leerlauf erhöht sich um so mehr, je mehr Sie das Gemisch im Motor abmagern.

D g. Einschalten der RC-Anlage

Ziehen Sie die Senderantenne ganz heraus.

Bei nicht vollständig herausgezogener Antenne verringert sich die Reichweite der Fernsteuerung.

ACHTUNG! Immer zuerst den Sender einschalten!



Einschalten des Empfängers

- Der Ein/Aus Schalter befindet sich auf der Empfängerbox.
- Befestigen Sie das Antennenröhrchen, durch das das Antennenkabel geführt wird (siehe Seite 73).
- Setzen Sie die Karosserie auf und sichern diese mit den Karosseriesplinten

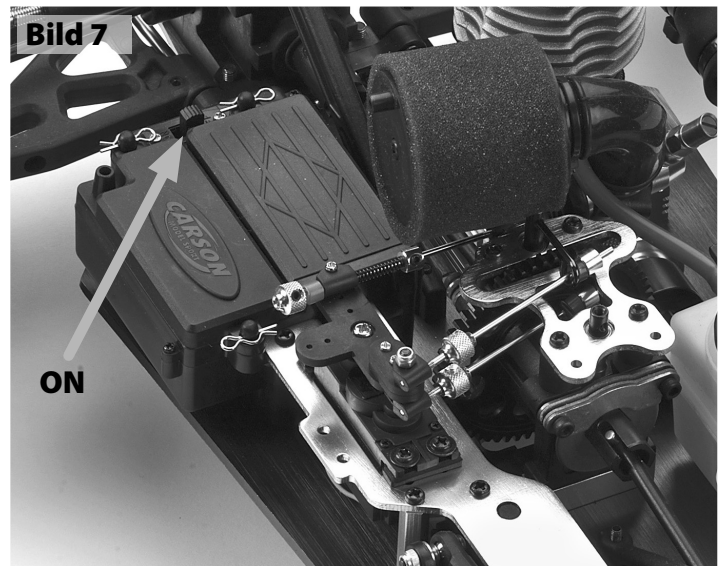

h. Steuern des Modells

- Stellen Sie das Modell so ab, dass die Räder frei in der Luft hängen.
- Drehen Sie das Steuerrad bis zum Anschlag nach rechts und links. Die Räder sollen dem Lenkausschlag folgen.
- Schlagen die Räder entgegengesetzt ein, betätigen sie den Servo-Reverse Schalter (ST in Position REV).
- Zum Regeln der Fahrgeschwindigkeit betätigen Sie den Gas/Bremshebel
 - nach hinten (Vorwärtsfahrt, Gas geben) bzw.
 - nach vorne (Bremsen, Rückwärtsfahrt).



i. Wartung und Pflege

Schäden, die daraus resultieren, dass der Motor nicht eingefahren wurde und/oder die durch falsche Einstellung entstehen, fallen nicht unter die Gewährleistungsgarantie.

Es gibt zwei verschiedene Möglichkeiten die Temperatur Ihres Motors zu überprüfen. Sie können sich eine Temperaturanzeige kaufen. Die zweite billigere Methode, jedoch weniger genau, ist der „Spucketest“. Reiben Sie etwas Spucke auf die Oberseite des Kühlkörpers und sie wird innerhalb von 3 – 4 Sekunden verschwinden (der Siedepunkt von Wasser ist normalerweise 100°C). Sollte die Spucke sofort verschwinden, ist die Wahrscheinlichkeit sehr groß, dass der Motor zu heiß gelaufen ist.

Der Motor bringt beste Leistung und kann einfacher wieder neu gestartet werden bei einer Betriebstemperatur von 100°C bis 125°C. Abhängig vom Wetter, Luftdichte und Luftfeuchtigkeit, muss die Einstellung des Vergasers vor jedem Gebrauch des Fahrzeuges verändert werden. Vorsichtiges Einstellen garantiert eine lange Lebensdauer Ihres Motors. Überhitzung erfolgt, wenn das Gemisch im Motor zu mager ist, oder wenn die Einstellung des Vergasers nicht der Wetterlage angepasst ist. Durch starke Überhitzung kann es zu Motorschäden kommen.

Es gibt viele Tipps und Infos Online, die Ihnen helfen, Ihren Motor einzustellen. 3,5 ccm Motoren haben eine sehr lange Lebensdauer und bei richtiger Wartung und Tuning können Sie das Modell stundenlang ohne Unterbrechung fahren.

Ausschalten

Nach Beendigung des Fahrens, gibt es zwei Möglichkeiten den Motor auszuschalten. Die erste Möglichkeit ist, ein Tuch dicht auf das Auspuffrohr zu drücken. Der Motor muss im Leerlauf sein, vorzugsweise sollten die Bremsen betätigt sein.

Die zweite Möglichkeit besteht darin, den Luftzugang zum Motor abzuklemmen. Der Kraftstoffschlauch sollte nicht abgeklemmt werden, weil sich der Motor dadurch überhitzen kann.

Versuchen Sie den übrig gebliebenen Kraftstoff durch den Motor laufen zu lassen, um so den Tank vollkommen zu entleeren. Die Motordrehzahl wird sich im Leerlauf erhöhen während der Tank sich entleert, somit sind die o.g. Schritte nicht nötig.



Benutzen Sie dann spezielles Öl (After-run Öl) für den Vergaser, ziehen Sie das Startseil ein paar Mal, damit sich das Öl im Motor verteilt. Dieser Vorgang empfiehlt sich, wenn Sie planen, das Auto mehr als einen Tag nicht zu fahren. Methanol verdunstet und wird zu Wasser, was für die Teile im Inneren des Motors schädlich sein kann. Wir empfehlen, dass Sie vor jedem Gebrauch Ihres Autos die Festigkeit aller Schrauben, Muttern und Bolzen überprüfen.



Das Auto sollte regelmäßig gereinigt werden. Dazu kann eine strapazierfähige Bürste oder ein Pinsel benutzt werden. Überprüfen Sie vor dem Start immer die Batterien von Sender und Empfänger.

Insider Tipp:

Benutzen Sie Handschuhe, wenn Sie an Ihrem heißen Auto arbeiten!

D j. Problembehandlung

Lesen Sie dies, schon bevor es passiert.

Der Motor springt nicht an

Motor ist abgeseoffen. Zu viel Benzin ist im Motor.	Entfernen Sie die Glühkerze. Ziehen Sie das Startseil 6 – 8 mal. Vorsicht, Kraftstoff kann spritzen.	Leerer Tank/ kein Kraftstoff im Motor	Füllen Sie den Tank auf. Lassen Sie den Motor ansaugen, indem Sie das Startseil einmal ziehen und gleichzeitig mit den Fingerspitzen den Auspuff zuhalten.
Kaputte Glühkerze	Entfernen Sie die Glühkerze. Stecken Sie die Glühkerze in den Zünder. Wenn diese schwarz ist, ist die Kerze kaputt. Sie sollte hell orange glühen.	Überhitzung	Wenn der Motor bei zu hohen Temperaturen läuft, kann dies dazu führen, dass ein Gaspfropfen entsteht. Lassen Sie den Motor 5 – 10 Minuten abkühlen.
Batterie des Glühkerzensteckers ist leer.	Legen Sie eine neue Glühkerze in den Glühkerzenstecker. Wenn diese nur sehr schwach oder überhaupt nicht glimmt, muss eine neue Batterie oder Akku eingelegt werden.		

Motor stirbt plötzlich ab

Überhitzung	Überprüfen Sie die Temperatur. Sollte diese über 130°C liegen, muss das Kraftstoffgemisch angereichert werden. Überprüfen Sie, ob die Räder sich frei bewegen können.	Schmutziger Luftfilter	Waschen Sie diesen mit Seife und Wasser, dann benützen Sie Luftfilteröl (N° 50 003 2648).
Die Druckleitung ist unterbrochen	Befestigen Sie die Kraftstoffleitung des Auspuffrohres wieder mit dem Benzintankdeckel.	Vergaser ist locker	Überprüfen Sie Vergaserhalterungsschraube und Mutter. Drücken Sie den Vergaser auf den Motorblock, ziehen Sie die Schraube fest, um Falschluf zu vermeiden.

Kontrollverlust/Störungen

Leere/schwache Akkus	Die Akkus im Sender sollten voll aufgeladen sein. Ist der Servo sehr langsam, bedeutet dies, dass die Batterien des Empfängers leer sind.	Modell fährt nicht geradeaus	Lenkungstrim ist nicht korrekt eingestellt. Radmuttern sind lose.
Falsche Einstellung des Senders	Richten Sie sich nach der Gebrauchsanweisung, wenn Sie Ihren Sender einstellen.	Modell bleibt nicht stehen	Trimmung für den Gas/Bremshebel ist nicht korrekt eingestellt.
Das Modell fährt nicht	Sender oder Empfänger sind nicht eingeschaltet. Polarität der Akkus oder Akkutyp sind falsch. Batterien/Akkus zu schwach.	Modell fährt zu langsam	Motor hat an Leistung verloren. Die hinteren Radmuttern sind lose. Staub/Fremdkörper ist in das Getriebe gelangt.

Dear Customer

We congratulate you for buying this CARSON RC model car, which is designed using state of the art technology.

According to our policy of steady development and product improvement we reserve the right to make changes in specifications concerning equipment, material and design at any time without notice.

Specifications or designs of the actual product may vary from those shown in this manual or on the box.

The manual forms part of this product. Should you ignore the operating and safety instructions, the warranty will be void. Keep this guide for future reference.

GB

Limited Warranty

This product is warranted by CARSON against manufacturing defects in materials and workmanship under normal use for 24 months from the date of purchase from authorised franchisees and dealers. In the event of a product defect during the warranty period, return the product along with your receipt as proof of purchase to any CARSON store. CARSON will, at its option, unless otherwise provided by law:

- Correct the defect by repairing the product without charging for parts and labour
- Replace the product with one of the same or similar design; or
- Refund the purchase price.

All replacement parts and products, and products on which a refund is made, become the property of CARSON. New or reconditioned parts and products may be used in the performance of warranty services.

Repaired or replaced parts and products are warranted for the remainder of the original warranty period. You will be charged for repair or replacement of the product made after the expiration of the warranty period.

The Warranty does not cover:

- Damage or failure caused by or attributable to acts of God, abuse, accident, misuse, improper or abnormal usage, failure to follow instructions, improper installation or maintenance, alteration, lightning or other incidence of excess voltage or current;
- Damage caused by losing control of your car;
- Any repairs other than those provided by a CARSON Authorised Service Facility;
- Consumables such as fuses or batteries;
- Cosmetic damage;
- Transportation, shipping or insurance costs; or
- Costs of product removal, installation, set-up service adjustment or reinstallation

This warranty gives you specific legal rights, and you may also have other rights which may vary according to the country of purchase.

Declaration of conformity

Dickie-Tamiya GmbH & Co. KG hereby declares that this model kit with radio, motor, battery and charger is in accordance with the basic requirements of the following European directives: 98/37 EG and 89/336/EWG and other relevant regulations of guideline 1999/5/EG (R&TTE).

The original declaration of conformity can be obtained from the following address:

Dickie-Tamiya GmbH & Co. KG • Werkstraße 1 • D-90765 Fürth • Germany



The explanation of the symbol on the product, packaging or instructions: Electronic devices are valuable products and should not be disposed of with the household waste when they reach the end of their running time! Help us to protect the environment and respect our resources by handing this appliance over at the relevant recycling points.

We wish you good luck and a lot of fun driving with your CARSON model car.

Before driving your new model carefully read these instructions!

Contents

Preface.....14

Included Items.....15

Safety Precautions.....16

Additional Items Needed for Starting the Engine.....17

Tools Needed for the Assembly.....18

a. Your Radio System18

b. Chassis.....19

c. Plug in Receiver Battery19

d. Check 1...2...3.....20

e. Final Preparations.....20

f. Showtime... almost!21

g. Turn the Power Switch on22

h. How to Control Your Model.....22

i. Care and Maintenance23

j. Troubleshooting24

Assembly instructions61

Screws.....81

Spare parts.....82

Tuning parts87

3,5 cm³ Motor.....89

Force 25R – 4,01 cm³ Motor.....91

Force 32 – 5,23 cm³ Motor.....93

Setup Sheet95

GB

Included Items



Transmitter
(included in RTR Version
only)

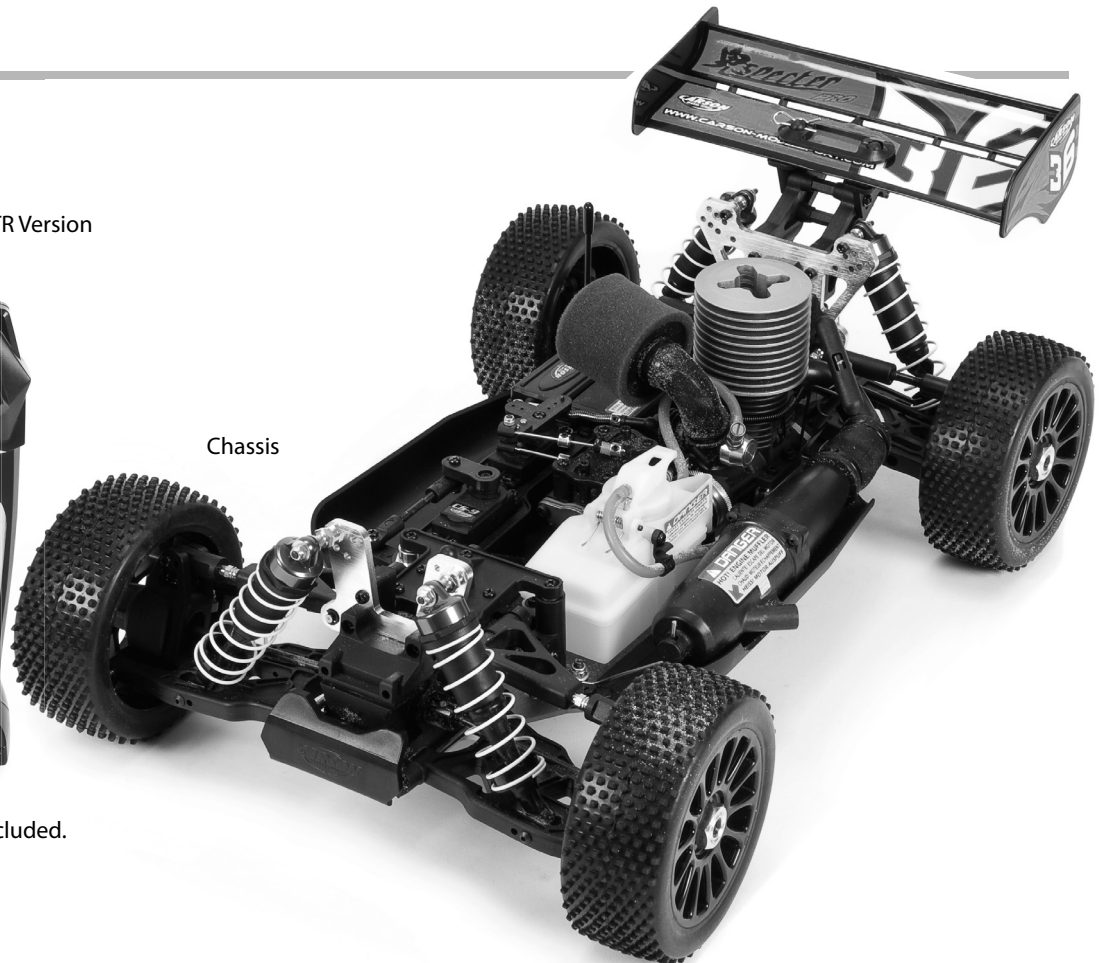

Chassis

With kit version RC and engine not included.

Safety Precautions

Safety precautions and operating guidelines

This radio control model vehicle must only be run on the approved model fuel. Always avoid running radio control models in restricted, confined or populated areas. Keep away from roads, highways, people and animals. Never run the model indoors.

GB No goods, people or animals may be transported using a RC model car with combustion engine.

Please ensure that you have read all the safety instructions and operating procedures before driving the model!

The body shell should be correctly attached to the vehicle before driving.

Allow cooling time for the exhaust and engine components before removing the body shell. These parts become extremely hot during operation and could cause serious injury.

Do not operate the model permanently where noise may cause a nuisance to others, because then you may damage your hearing.

To avoid the model running with a faulty control system causing it to drive erratically, check that the batteries in the transmitter and receiver are properly charged.

Always check that all the nuts, bolts and screws and components are not loose. Retighten and adjust as necessary.

Fill the fuel tank and firmly push the tank lid shut. Clean up any fuel spillages. Never leave fuel in the fuel tank.

This model is not a toy!

- This radio controlled model is not a toy. Learning how to control it correctly is a gradual process.
- Children under 14 years of age should be supervised by an adult.

Driving a radio controlled car is a fascinating hobby. However, it has to be practised with the necessary caution and respect. A radio controlled model car can cause damage and injury and the user is liable for any such incident. If driven erratically, a fairly heavy remote-controlled model car which is capable of reaching a high speed can

cause substantial damage and injury for which you as the operator are responsible.

Make sure that you have sufficient insurance cover when practising your hobby. Only a well maintained model will function in a correct manner.

Never improvise using unsuitable parts and tools. If necessary only use original spare parts. It is the user's responsibility to ensure that the model is functioning correctly and that all nuts, bolts and screws are properly tightened.

Never drive without first making sure of the following points:

- Batteries for transmitter and receiver are well charged and of the correct voltage.
- Always check the range of radio operation before starting the car.
- Make sure that all servos respond correctly to the signals of the transmitter.
- All operable parts are in good condition and you have tested their operation.
- You have made sure that all screws are tightened.
- There is no other RC or similar transmitter nearby, which could cause interference. Any further radio signal on the same frequency can cause the loss of control for your model. Always switch on the transmitter first to avoid any uncontrolled reaction of the receiver to a foreign radio impulse.
- Fully extend the transmitter antenna and make sure that nobody in your environment controls a model with the same frequency (number on the crystal) and that there is no discernable interference. To end the operation switch off the receiver first, then the transmitter.
- Keep your car away from high voltage cables or radio masts. Never use the model during lightning!
- Atmospheric disturbances can affect the signals of your remote controlling transmitter.
- Do not use the model in wet areas. The electrical connection of the model is not waterproof. Therefore do not drive while it's raining, snowing, or in puddles or wet grass.
- Always avoid running radio control models in restricted, confined or populated areas.
- Keep away from roads, highways, people and animals!
- Do not drive, if you are overtired or your reactivity is impaired in another way.
- Watch your model constantly and do not become distracted.
- The body shell should be correctly attached to the vehicle before driving.
- Regular maintenance and servicing are required to ensure top performance.
- Allow cooling time for the engine components before removing the body shell. Some parts (e.g. the motor and the muffler) become extremely hot during operation and could cause serious injury.

Pay attention to charge announcement of your transmitter.

- Ensure that the batteries for the radio and receiver are fully charged and of the correct voltage. When the batteries are running low you might lose control of your model.
- Never use fully loaded batteries and batteries which have already run low, or batteries of a different capacity at the same time.
- Never load batteries which are not rechargeable

If you do not use the model for a longer time you must remove the rechargeable battery.

Please read the following points concerning the fuel:

- Keep the fuel in a secure and safe place and away from children and animals.
- Ensure that the container lid is tightly closed.
- Store the fuel in a well ventilated area and away from moisture.
- Glow fuel is extremely flammable. Do not smoke.
- Avoid skin contact and do not swallow. Read the warning labels on the container.

Dispose of empty fuel containers in an approved manner. Never throw empty cans into a fire.

In case of an accident or ingestion contact a doctor immediately. (Present the label of the fuel container if possible.)

Finally

Please read the instructions before operating your model.

Each time you have finished driving the model, always check the correct operation of the components. A single loose screw can result in a dangerous situation for your model. Maintain your model regularly and replace damaged or worn out parts by genuine spare parts.

We wish you great fun with your CARSON model car!

GB

Additional Items Needed for Starting the Engine

Glow plug heater
50 090 5042



After Run Oil
50 090 5044



Air Filter Oil
50 003 2648



Fuel bottle
50 001 3330

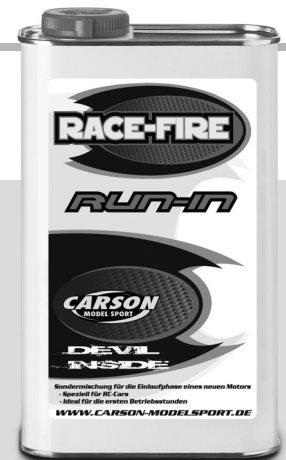

Fuel

Nitro set
50 090 5072



CARSON-fuels are recommended

Liter	Nitromethan	N°	Usage
1,0	10%	50 090 5052	Run in/Beginner
1,0	16%	50 090 5053	Normal
2,5	16%	50 090 5054	Normal
1,0	25%	50 090 5055	Race
2,5	25%	50 090 5056	Race

CARSON-ROSSI glow plugs

N°	Article	Motor	Fuel	Temperature
50 090 5006	Glow plug Rossi R2 hot	2 - 3,5 ccm	without Nitro	+0° - +15°C
50 090 5007	Glow plug Rossi R3 medium	3,5 - 6 ccm	without Nitro	-2° - +18°C
50 090 5008	Glow plug Rossi R4 cold	6 - 10 ccm	without Nitro	-5° - +20°C
50 090 5009	Glow plug Rossi R5 extra	3,5 - 10 ccm	10% Nitro	-7° - +22°
50 090 5010	Glow plug Rossi R6 cold	universal	10-13% Nitro	+10° - +25°
50 090 5011	Glow plug Rossi R7 cold	universal	13-15% Nitro	+15° - +30°
50 090 5012	Glow plug Rossi R8 extra cold	universal	13-15% Nitro	+20° - +40°



For the transmitter you need 8 AA batteries/rechargeable batteries.

Tools Needed for the Assembly

Modelling knife 30 007 4053

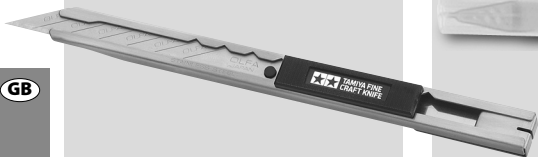

Instant adhesive 30 005 3339



Needle nose pliers 30 007 4034



Scissors 30 001 3305



Philips screwdriver (small and big) and hex-wrench 1,5/2/2,5 mm 30 007 4023

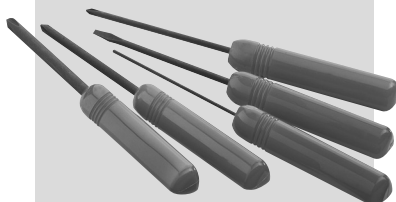

Hexagonal wrench 30 001 3118



Tweezers 30 007 4003

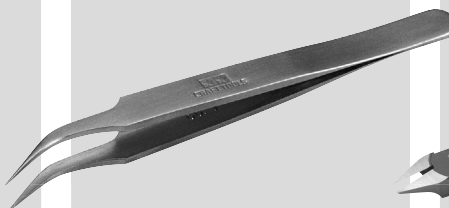

Side cutter 30 007 4035

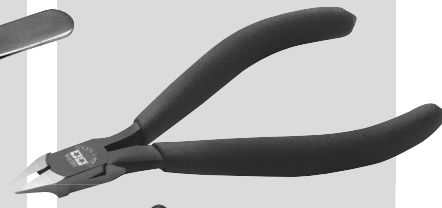

a. Your Radio System (only for RTR version)

Please read the instructions provided with your radio system before using it.

The servos must be set at the centre position before installation. To set the servos at a neutral position, turn on the transmitter and receiver. Set the trim levers in the centre position and turn off the receiver, and then the transmitter. The servos will be in proper neutral position for installation.

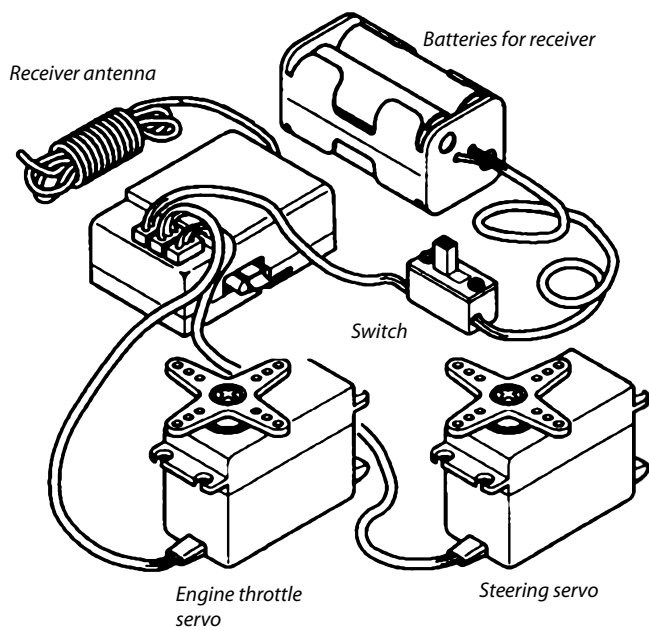

b. Chassis

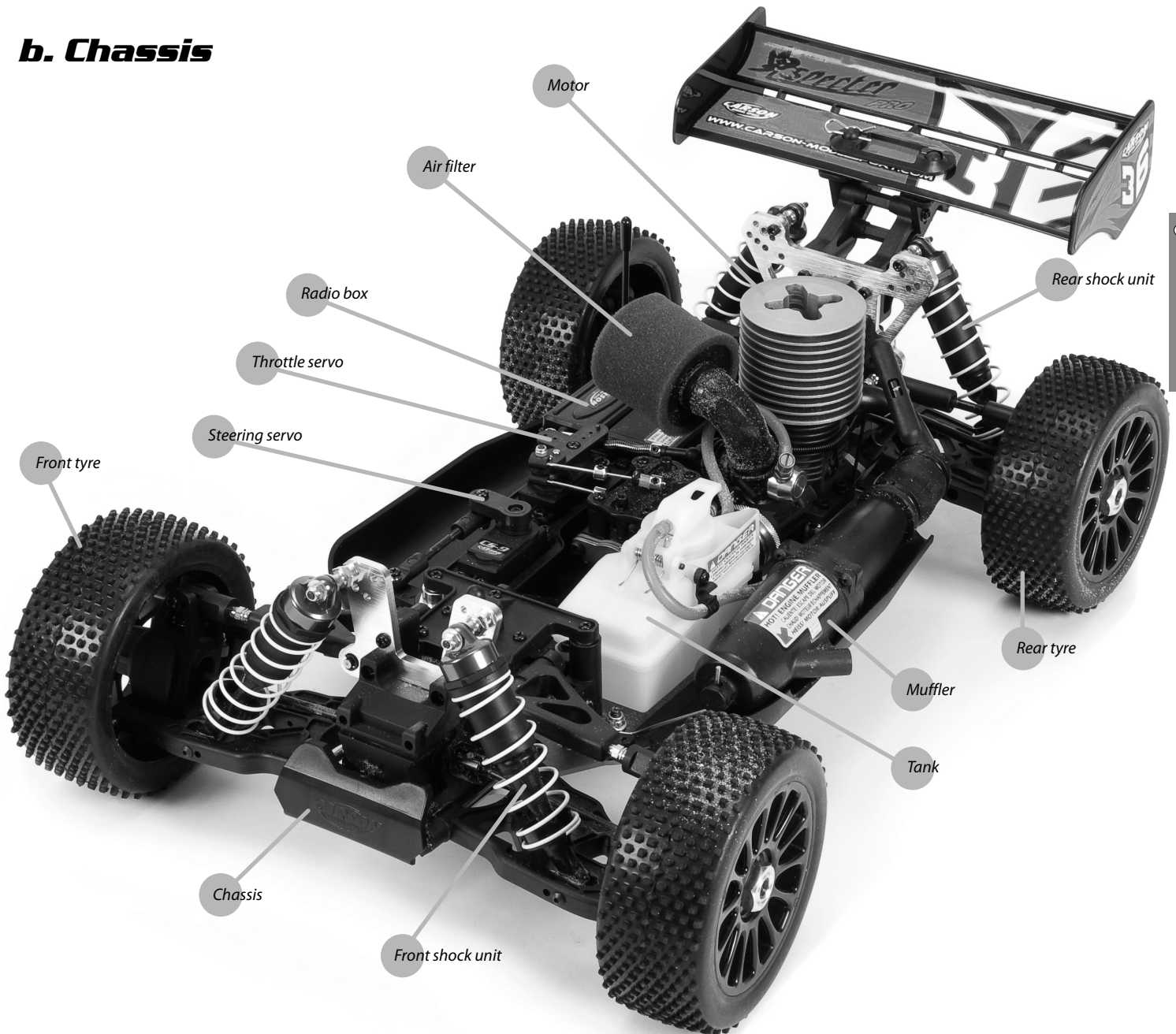

c. Plug in Receiver Batteries

Insert 4 "AA" batteries into the receiver battery case as shown (compare picture 1). Make sure positive (+) and negative (-) ends are facing the correct direction. Then plug the pack into the switch harness, inside the radio case. Black goes to black and red goes to red. Replace the radio case cover.

Racer Tip:

Use rechargeable batteries! They last longer and are cheaper in the long run. Replace the 4 "AA" car batteries with our NiMH 6 V/ 1100 mAh battery pack (50 060 8036 JR) (50 060 8037 BEC) for longer life and economy.

Picture 1



d. Check 1...2...3...

Always turn the radio on before turning your car on. Now you can switch on your car using the on/off switch located on the radio box.
Note: Always check your radio settings before running your car!

Check to make sure your steering is centred. If it is not, use the ST-TRIM knob to the left of the steering wheel. Turning left should make the car turn left. Right = right.

GB

Now it's time to set the throttle neutral position. Remove the air cleaner from the carburettor.

The opening on the carb slide should be open very little, from 1-1.5 mm to allow the engine to idle (picture 2). If it is open more than this, the engine may rev higher than normal until brakes are applied. This condition may wear out the brakes and/or clutch shoes prematurely making the car difficult to drive.

Use the TH-TRIM tab (picture 3) to move the servo arm into the neutral position if necessary. While in neutral, the brakes should not be set to "drag". Adjusting the collars with a 1.5 mm hexagonal wrench will change your drag brake settings. Replace the air cleaner when everything is adjusted to your satisfaction.

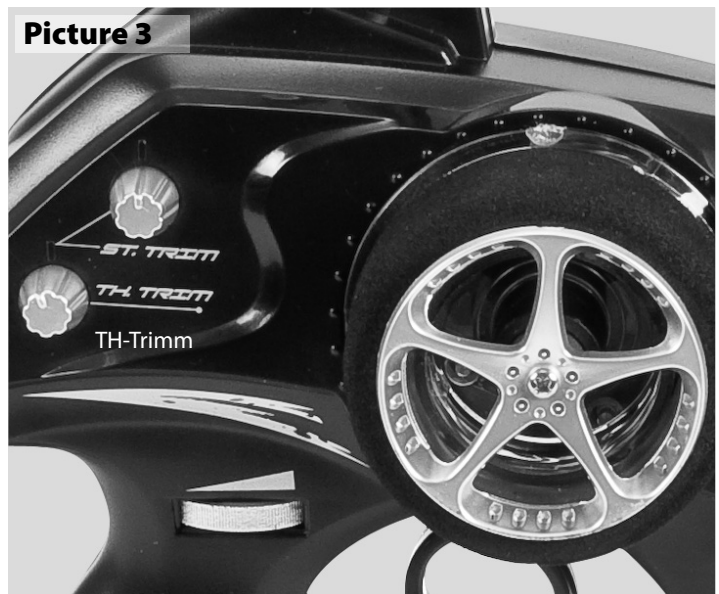

e. Final Preparations...

Assemble the fuel bottle. Fill the fuel bottle by compressing it and then insert the spout into the fuel. Allow the bottle to decompress and the suction will fill the fuel bottle. Fill the tank by gently squeezing the bottle and ensure that the tank lid is firmly shut when finished.

Racer Tip 1:

Fuel will stay fresh longer if you store it in a cool, dark and dry place.

Racer Tip 2:

Never leave the glow heater on your engine for more than 10 seconds. A longer time may cause the glow plug to burn out prematurely. Use rechargeable glow heaters for longer life.

Racer Tip 3:

To start the motor, use a fireproof glove!

f. Showtime... almost!

Engine break-in is the most important step to assuring that your engine is fast and reliable throughout its life. Put simply: DON'T SKIP THIS PART!

The engine is pre-set from the factory for break-in. Use a "FAT BONE" 50 090 5034 or platform and place the car so that the wheels are off the ground and free.

Make sure the throttle is set at neutral with your radio. Place the glow heater onto the glow plug and give the recoil a sharp pull (picture 4). Do not pull it more than twelve inches! More than that may break the cord and this is not covered under warranty. It is better to give the recoil short sharp pulls rather than long ones. If the pull-start cord gets stuck, rotate the flywheel a little bit with your finger. This should make the cord automatically recoil. Within a few pulls, the engine will start with a good puff of smoke.

If the engine has trouble idling at the rich setting, turn the idle screw clockwise 1/8th of a turn at a time. This will increase the idle allowing the car to break-in properly. Try to do this in a well-ventilated area,

Picture 4



such as your driveway. Unburned oil from the fuel will accumulate under the exhaust, so be prepared. Let the car idle like this for 2 - 3 tanks of fuel checking the engine temperature every 2 minutes. Please allow a break of 10 - 15 in between filling the tank to allow the engine to cool down. You should be able to touch the head of the engine with your fingertips and it will be hot, but not uncomfortably so. (Attention! Do not touch!) If it seems very hot, richen (turn counter-clockwise) the high-end and low-end needles 1/8th of a turn. Always use small increments when making these kinds of adjustments.

Racer Tip:

Factory setting of carburettor:

With the following basic adjustment the engine starts immediately, running perfect and rich enough (outside temperature 8°C).

- Idle stop screw: approx. 1 mm air gap;
- High speed needle valve: screw in completely, then open 4 full turns;
- Low speed needle valve (linking): flush with the edge of the linking arm, then 1 full turn clockwise;

After run-in is finished the high speed needle valve should be open at least 3 and 1/4 turns. A richer setup is better if outside temperature is high.

Picture 5

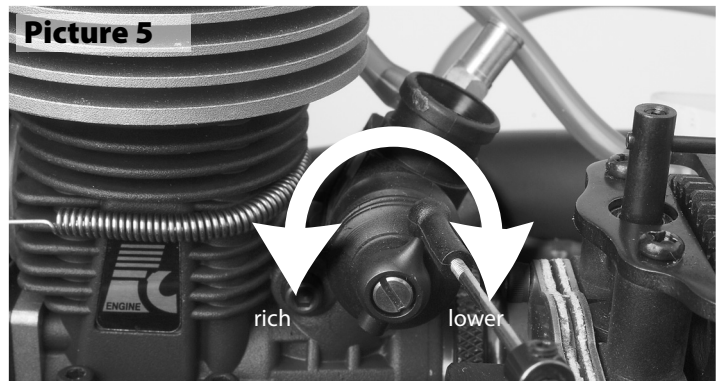

Picture 6

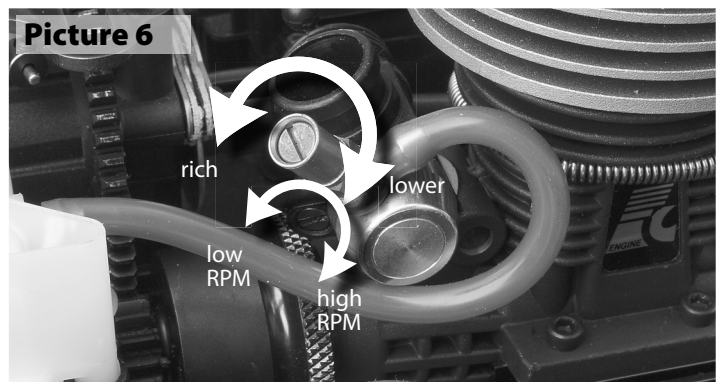

Racer Tip:

Drive your car slowly with the rich setting shortly after the break-in period avoiding prolonged periods at full throttle. Gradually lean out the mixture 1/8 of a turn at a time. The idle will increase the more you lean the engine out.

g. Turn the Power Switch on

Pull the transmitter antenna out completely.

The range of the remote control is reduced if the antenna is not pulled out completely.

CAUTION!

Always turn the transmitter's power switch ON first!

GB



Switch on the receiver

- Power switch is on the radio box.
- Fix the receiver antenna and wire (see page 73).
- Put the body on and fix it with the body split pins.

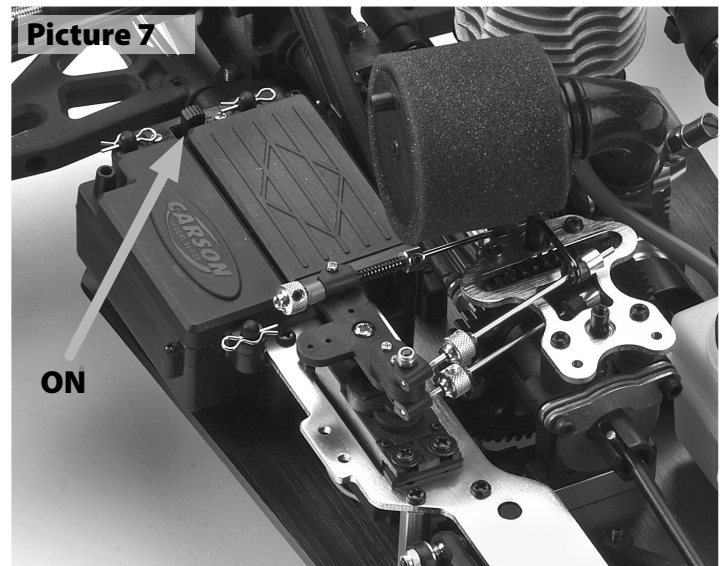

h. How to Control Your Model

- Raise the tyres off the ground
- Turn the steering wheel to the right and left as far as it will go. The wheels are to follow the steering direction.
- If the wheels operate in the opposite direction, operate the servo Reverse switch (ST in position REV).
- To regulate the driving speed, actuate the throttle/brake
 - backwards (forward driving, accelerating) or
 - forwards (braking, reversing).



i. Care and Maintenance

Failure to follow break-in procedure and/or damage caused by improper tuning will void your engine warranty.

There are two ways to “temp” your engine. One, purchase a temperature gauge. The second cheaper, but less accurate method is the “Spit Test”. Wipe a little bit of saliva on the engine head and it should burn off in 3 - 4 seconds (the boiling point of water normally is 100 °C). If it evaporates immediately, chances are the engine is running too hot.

The engine will run best and be easier to restart if run around 100-125 °C. Depending on your weather conditions, air density, and humidity, your carburettor settings will be changing wherever you decide to run. Making adjustments in small increments is the best way to make sure your engine lasts a long time. Overheating is caused by running the engine too lean, or too much stress on the engine created by the environment. Extreme overheating will result in internal failure of engine parts.

There are many online resources that will help you with engine tuning. 3,5 ccm engines are designed to last a long time, and with proper maintenance and tuning, you can drive the model for hours at a time.

After Use

When you have finished running your car, there are two options to shut the engine down. The first method is to place your thumb over the exhaust outlet (Wear gloves). Make sure your engine is normal idle, preferable with the brake activated.

The second method is to pinch off the air supply from the engine. Do not pinch the fuel line, as this may cause the engine to overheat!

Try and let all the remaining fuel run through the engine, emptying the fuel tank. The engine will idle high while the tank is emptied, so the above two steps may not be necessary.

Picture 8



Then apply after-run oil through the carburettor, and pull the pull-start a few times to get it through the engine. This is recommended if you plan on storing the car for more than a day. Methanol evaporates in water and can cause internal corrosion to engine parts. It is always a good idea to check all the screws, nuts, and bolts before and after each period of racing.

Picture 9

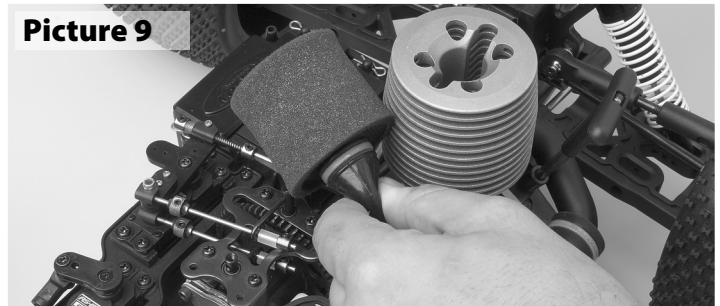

Keeping the car clean will also make it more fun to work on. This can be achieved with a large heavy-duty paintbrush, or compressed air. Always test the transmitter and receiver batteries before starting the engine.

Racer Tip:

Wear gloves when working on your hot car!

j. Troubleshooting

Please read this before something happens.

Engine won't start.

Engine flooded. Too much fuel in engine	Remove glow plug. Pull pull-start 6-8 times, Beware of spraying fuel.
Dead glow plug heater	Remove glow plug. Place glow plug in heater. If the glow plug does not glow orange the plug maybe dead. See also glow heater. (Wear gloves)
Dead glow heater battery	Place new glow plug in heater. If it glows dim or not at all, replace heater battery.

Empty fuel tank/ No fuel in engine	Fill fuel tank. Prime engine by pulling pull-start once while holding finger tip over muffler (Wear gloves).
Overheating	Running at high temperatures may cause vapour lock. Let the car cool down for 10-15 minutes

Engine stalls

Overheating	Check temperature. If over 130 °C, richen carb mixture. Check to make sure wheels spin freely.
Disconnected fuel pressure line	Reattach pressure line from exhaust pipe to fuel tank lid.

Dirty air cleaner	Wash with soap and water, then use air filter oil (N° 50 003 2648).
Carburettor loose	Check carb-lock bolt and nut. Press carb onto engine block, tighten nut to prevent air leak.

Hard to control, "glitching"

Dead/weak batteries	Batteries in transmitter should be fully charged. Slow servos mean dead receiver batteries.
Improper transmitter settings	Refer to instructions on setting up your transmitter
Model doesn't move	Transmitter or chassis power switch is not „ON“ Polarity or battery type is wrong Batteries have run down

Doesn't run straight	Steering trim is not adjusted correctly Front and rear wheel nuts are too loose
Doesn't stop	Throttle trim is not adjusted correctly
Running too slowly	Motor has lost power Rear wheel nuts are too loose Dust or foreign objects are inside gears

Cher client

Toutes nos félicitations pour l'acquisition de votre voiture en modèle réduit CARSON RC, un modèle dernier cri.

En vertu de notre engagement pour un développement et une amélioration continus de nos produits, nous nous réservons le droit d'effectuer des modifications dans les spécifications de nos équipements, nos matériaux et de notre conception à tout moment et sans avertissement préalable.

Les spécifications ou les versions du produit acheté peuvent différer de celles affichées dans le manuel ou sur l'emballage. Le présent manuel fait partie du produit.

Tout non-respect des instructions et des consignes de sécurité qui y sont incluses dispense le fabricant de toute garantie. Conserver le présent manuel comme document de référence, et également pour pouvoir le transmettre par la suite à un tiers avec la voiture.

Conditions de garantie

F CARSON vous garantit pour 24 mois à partir de la date d'achat (pièces justificatives à l'appui) que la voiture est exempte de tout défaut. L'utilisation inappropriée, l'usure des éléments au cours de l'utilisation, les transformations de votre propre chef, l'application ou l'utilisation incorrecte, l'endommagement des batteries ou d'autres équipements au cours de l'utilisation ou l'emploi abusif un l'endommagement causé par le transport, n'est pas couvert par la responsabilité civile. En cas de défaut survenant durant la période de garantie, rappez la maquette avec le justificatif d'achat à votre distributeur.

CARSON décide alors, sauf dispositions autres prévues par la législation :

- De remédier gratuitement au défaut de matériel et de fabrication en réparant le produit ;
- De remplacer le produit par un produit identique ou similaire ; ou
- De rembourser le prix de vente.

Notre garantie se limite à la réparation ou à l'échange des appareils dans l'état original et à la hauteur du prix d'achat. L'utilisateur de la voiture assume tous les risques en rapport avec l'utilisation de la voiture.

Les pièces réparées ou remplacées ne sont sous garantie que pour la durée restante de la période de garantie initiale. Après expiration de la période de garantie, les réparations effectuées ou les pièces détachées fournies sont facturées.

La garantie ne couvre pas :

- Tout dommage ou défaillance causé par force majeure, abus, accident, utilisation abusive, erronée ou anormale, non respect des instructions, mauvaise mise en route ou maintenance insuffisante, altération, éclair ou tout autre conséquence d'une surtension ou d'un courant excessif ;
- Tout dommage provoqué par la perte de contrôle de la voiture ;
- Toute réparation autre que celles réalisées par un organisme agréé par CARSON ;
- Les consommables tels que les fusibles et les batteries ;
- Des dommages esthétiques ;
- Le transport, l'expédition et les frais d'assurance ; et
- Les frais de retour, d'installation, de mise au point et de remise en route du produit

Cette garantie vous attribue des droits spécifiques, vous pouvez par ailleurs également prétendre à d'autres droits en fonction du pays d'achat.

Déclaration de conformité

Dickie-Tamiya GmbH & Co. KG déclare par la présente que ce kit de modélisme, avec émetteur, moteur, batterie et chargeur respecte les exigences de base des directives européennes suivantes : 98/37 EG et 89/336/EWG ainsi que les autres régulations de la directive 1999/5/EG (R&TTE).

La déclaration de conformité originale peut être demandée à l'adresse suivante :

Dickie-Tamiya GmbH & Co. KG • Werkstraße 1 • D-90765 Fürth • ALLEMAGNE



Signification du symbole se trouvant sur le produit, l'emballage et le mode d'emploi :

Les appareils électroniques sont des produits de valeur et ne doivent pas être éliminés avec les autres déchets ménagers une fois parvenus à la fin de leur cycle de vie. Aidez-nous à préserver l'environnement et à respecter nos ressources en remettant cet appareil aux points de recyclage concernés.

Nous vous souhaitons beaucoup de plaisir avec la conduite de votre modèle réduit CARSON.

Lire attentivement ces instructions avant d'utiliser ce nouveau modèle réduit.

Contenu

Préface.....	26
Périmètre de livraison.....	27
Consignes de sécurité.....	28
Articles nécessaires au démarrage du moteur.....	30
Outils nécessaires au montage de la voiture.....	31
a. Votre ensemble de radiocommande.....	31
b. Châssis.....	32
c. Alimentation du récepteur.....	32
d. Test de fonction.....	33
e. Ultimes préparations.....	33
f. Mise en route.....	34
g. Allumer l'émetteur.....	35
h. Conduite de la voiture.....	35
i. Entretien et maintenance.....	36
j. Élimination de pannes.....	37
Assemblage.....	61
Vis.....	81
Pièces détachées.....	82
Pièces tuning.....	87
3,5 cm ³ Moteur.....	89
Force 25R – 4,01 cm ³ Moteur.....	91
Force 32 – 5,23 cm ³ Moteur.....	93
Fiche de montage.....	95

F

Périmètre de livraison



Emetteur
(compris dans la
version RTR)

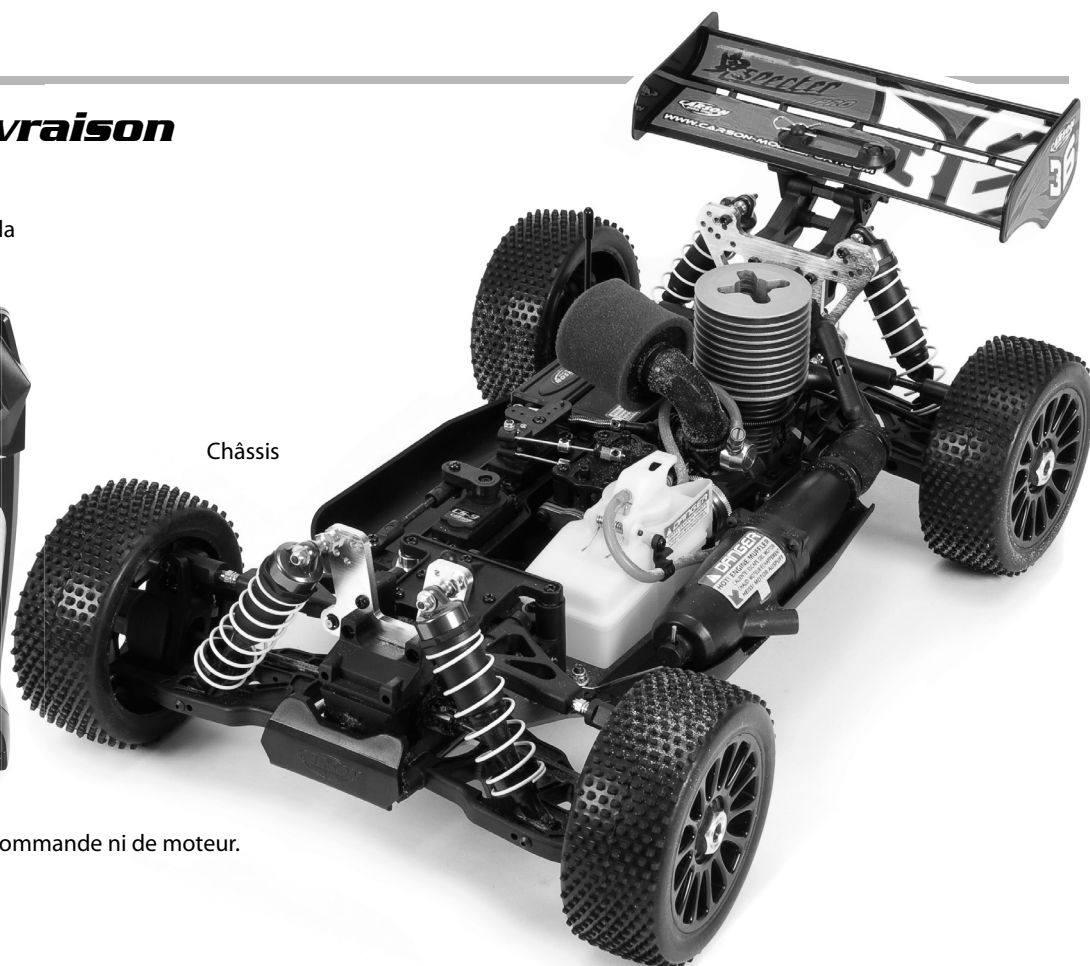

Châssis

La version kit ne contient pas de télécommande ni de moteur.

Consignes de sécurité

Guide des précautions d'utilisation

Ce modèle radiocommandé doit uniquement être utilisé avec le carburant préconisé. Toujours utiliser les modèles radiocommandés dans des lieux sécurisés. Ne pas utiliser sur les voies de circulation, près du public ou d'animaux. Ne pas utiliser en intérieur.

Une maquette de voiture RC à moteur à combustion interne ne doit pas servir à transporter des marchandises, des personnes ou des animaux.

Lire attentivement les consignes de sécurité et d'utilisation avant de piloter la voiture!

La carrosserie doit être correctement fixée sur la voiture avant le démarrage.

F Attendre que le moteur et l'échappement soient refroidis avant de retirer la carrosserie. Ces parties deviennent très chaudes pendant l'utilisation et peuvent causer des brûlures graves.

La maquette ne doit pas être utilisée de manière prolongée à proximité immédiate de personnes, car cela peut entraîner des lésions auditives dans certains cas.

Pour éviter les perturbations du système de commande, ce qui se traduirait par une marche incontrôlée de la maquette, il convient de vérifier que les piles de l'émetteur et du récepteur sont parfaitement chargées.

Toujours vérifier que les écrous et les vis sont correctement serrés et que toutes les pièces sont fixées. Revisser et ajuster si nécessaire.

Remplir le réservoir de carburant et refermer soigneusement le bouchon. Essuyer le carburant renversé.

Ce modèle n'est pas un jouet !

- Un modèle télécommandé n'est pas un jouet, sa manipulation doit être apprise progressivement.
- Les enfants de moins de 14 ans ne doivent pas conduire la voiture sans être accompagnés d'un adulte.

La conduite d'une voiture radiocommandée est une activité passionnante. Elle doit toutefois être exercée avec la prudence et l'attention nécessaires. Une voiture télécommandée d'un certain poids peut, lorsqu'elle atteint une grande vitesse, provoquer des dégradations et des blessures graves en cas de perte de contrôle du véhicule et c'est vous qui seriez responsable en tant qu'utilisateur.

Assurez-vous de disposer d'une couverture d'assurance suffisante pour pratiquer cette activité. Seul un modèle bien entretenu fonctionnera de manière correcte.

N'utiliser que des pièces détachées homologuées et ne jamais improviser de réparations avec des éléments inadaptés. L'utilisateur est responsable du bon fonctionnement de la voiture et du bon serrage de tous les écrous, boulons et vis.

Ne jamais démarrer sans avoir vérifié les points suivants :

- Les batteries de l'émetteur et du récepteur sont correctement chargées et sont à la bonne tension.
- Toujours vérifier la portée de la radiocommande avant de démarrer la voiture.
- Vérifier que les servos répondent correctement aux signaux de l'émetteur.
- Toutes les pièces mobiles doivent être en bon état et fonctionner correctement.
- Vérifier que toutes les vis sont serrées.
- Vérifier qu'il n'y a pas d'émetteur RC ou similaire à proximité qui pourrait provoquer des interférences. Tout signal radio de la même fréquence peut entraîner une perte du contrôle de la voiture. Toujours allumer l'émetteur en premier pour éviter toute réaction incontrôlée du récepteur par rapport à un signal radio extérieur.
- Sortir complètement l'antenne et s'assurer qu'aux alentours, personne ne commande un modèle réduit avec la même fréquence (valeur sur le quartz) et qu'il n'y a pas d'interférence visible. A la fin de l'utilisation, couper tout d'abord le récepteur, puis l'émetteur.
- Maintenir la voiture éloignée des câbles haute tension ou des antennes radio. Ne jamais utiliser la voiture par temps d'orage !
- Les perturbations atmosphériques peuvent affecter les signaux de l'émetteur.
- Ne pas utiliser la voiture dans les zones humides. Les raccords électriques de la voiture ne sont pas étanches. Pour cette raison, ne pas conduire sous la pluie, la neige ou à travers des flaques d'eau ou de l'herbe mouillée.
- Toujours éviter de conduire les modèles radiocommandés dans des lieux fermés, confinés ou densément peuplés.
- Maintenir éloigné des routes, autoroutes, des gens et des animaux.
- Ne pas conduire en cas de fatigue importante ou dans le cas d'une réactivité altérée de quelque autre manière.
- Toujours conserver la voiture dans le champ visuel, ne pas se laisser distraire.
- La carrosserie doit être correctement attachée au véhicule avant le démarrage.
- Une maintenance et un entretien réguliers sont nécessaires pour des performances optimales.
- Certaines pièces (p.ex. le moteur et le silencieux) peuvent devenir extrêmement chaudes lors d'une utilisation prolongée et peuvent entraîner des blessures graves.

Bien tenir compte des indications de charge de l'émetteur.

- S'assurer que les batteries de l'émetteur et du récepteur sont correctement chargées et à la bonne tension. Des batteries déchargées peuvent entraîner une perte de contrôle de la voiture.
 - Ne jamais utiliser simultanément des piles pleines et des piles partiellement déchargées, ou des batteries de capacités différentes.
 - Ne jamais tenter de recharger des piles.
- En cas d'immobilisation prolongée de la voiture, retirer les batteries.

Lire attentivement les conseils suivants concernant le carburant :

- Stocker le carburant dans un endroit sécurisé et hors de portée des enfants et animaux.
- S'assurer que le bidon est correctement fermé.
- Stocker dans un lieu bien ventilé et à l'abri de l'humidité.
- Le carburant est extrêmement inflammable. Le tenir éloigné de toute source de chaleur, de flammes nues, d'équipements électriques et de batteries. Ne pas fumer à proximité.
- Eviter tout contact avec la peau et ne pas inhaler. Lire les consignes de sécurité sur le bidon.

Eliminer les bidons vides dans un lieu approprié. Ne jamais jeter les bidons vides dans le feu.

En cas d'accident ou de malaise, contacter immédiatement un médecin (si possible, présenter l'étiquette du carburant).

Derniers conseils :

Lire attentivement le présent mode d'emploi avant toute utilisation.

Après chaque utilisation, les parties importantes et les connecteurs de la voiture doivent être inspectés. Une pièce défectueuse peut provoquer à elle seule un accident. Vérifier régulièrement la voiture et remplacer si nécessaire les pièces défectueuses avec des pièces de rechange d'origine.

Nous vous souhaitons beaucoup de plaisir avec votre modèle réduit CARSON !

Articles nécessaires au démarrage du moteur

Pince à bougie
50 090 5044



Huile de protection
50 090 5044



Huile de filtre à air
50 003 2648



Pipette à essence
50 001 3330



Essence

Set de Nitro
50 090 5072



Essence CARSON recommandée

Litre	Nitromethan	N°	Application
1,0	10%	50 090 5052	rodage/ débutants
1,0	16%	50 090 5053	Normal
2,5	16%	50 090 5054	Normal
1,0	25%	50 090 5055	Race
2,5	25%	50 090 5056	Race

CARSON-ROSSI pince à bougies

N°	Article	Moteur	Carburant	Température
50 090 5006	Bougie Rossi R2 chaude	2 - 3,5 cm ³	sans nitrométhane	+0° - +15°C
50 090 5007	Bougie Rossi R3 moyenne	3,5 - 6 cm ³	sans nitrométhane	-2° - +18°C
50 090 5008	Bougie Rossi R4 froide	6 - 10 cm ³	sans nitrométhane	-5° - +20°C
50 090 5009	Bougie Rossi R5 extra	3,5 - 10 cm ³	10% nitrométhane	-7° - +22°
50 090 5010	Bougie Rossi R6 froide	universel	10-13% nitrométhane	+10° - +25°
50 090 5011	Bougie Rossi R7 froide	universel	13-15% nitrométhane	+15° - +30°
50 090 5012	Bougie Rossi R8 extra froide	universel	13-15% nitrométhane	+20° - +40°

L'émetteur utilise 8 piles ou batteries AA.



Outils nécessaires au montage de la voiture

Couteau de bricolage 30 007 4053

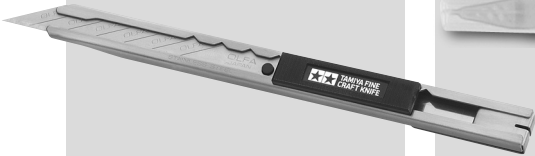

Colle à prise rapide 30 005 3339



Pincettes 30 00 4034



Ciseaux 30 001 3305



Tournevis (petit et grand)
et clé à six pas
1,5 / 2 / 2,5 mm 30 007 4023

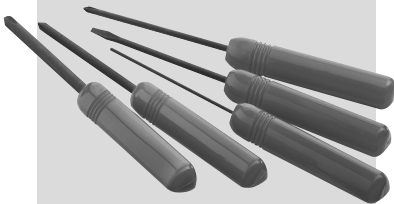

Clé hexagonale (Allen) 30 001 3118



Pincette 30 00 4003



Pincettes coupantes 30 00 4035



F

a. Votre ensemble de radiocommande

(uniquement pour la version RTR)

Lire attentivement le mode d'emploi fourni avec le système de radiocommande avant de s'en servir.

Les servos doivent être réglés sur neutre avant leur montage dans la voiture. Pour atteindre cette position, allumer l'émetteur, mettre les manettes sur neutre et ensuite allumer le récepteur, les servos sont maintenant au neutre. Eteindre l'émetteur tout en prenant soin de ne plus déplacer les servos.

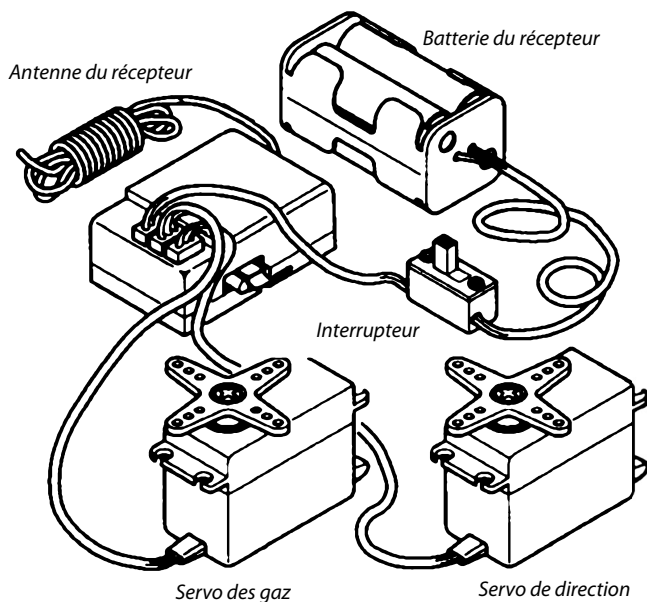

b. Châssis

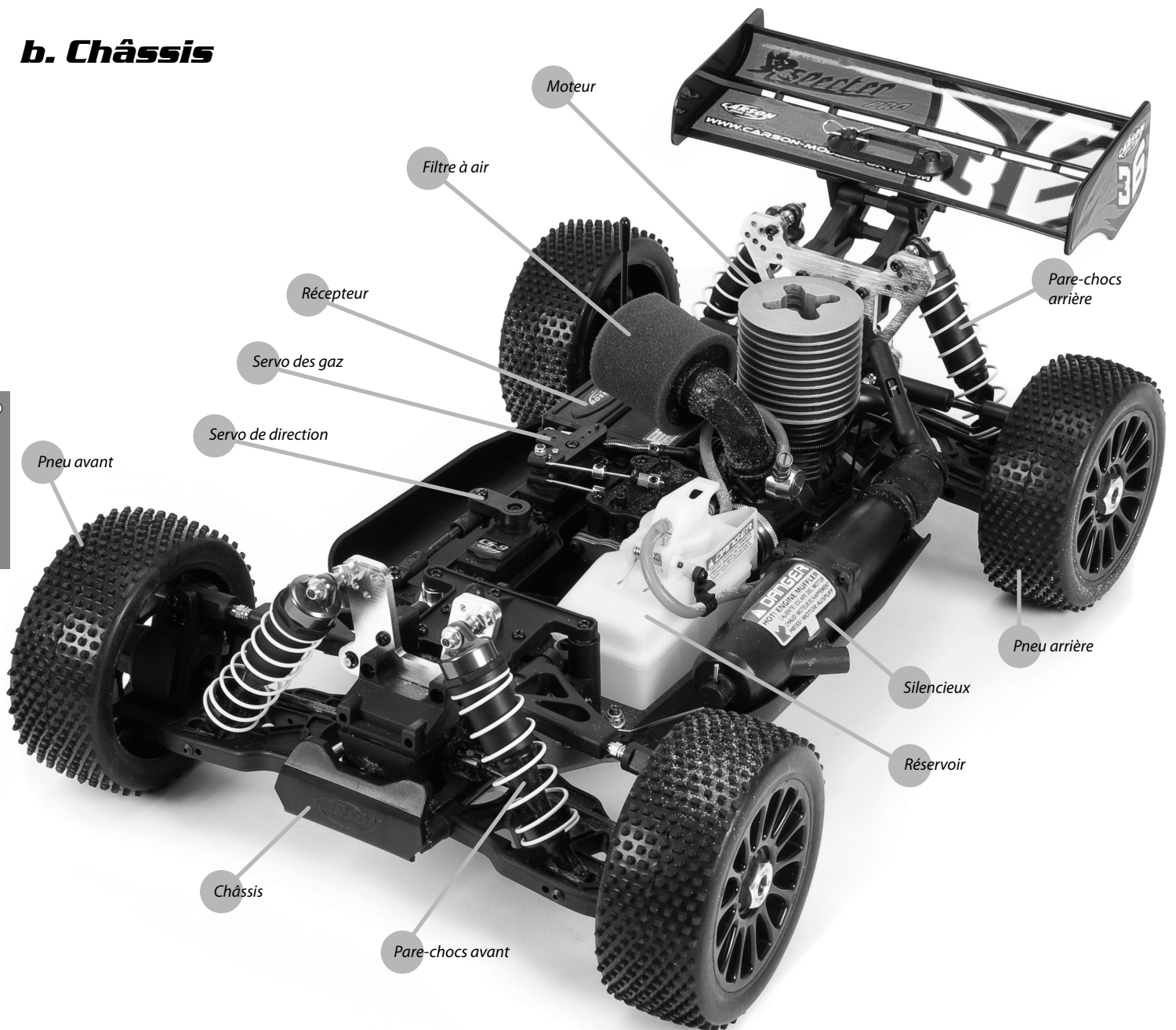

c. Alimentation du récepteur

Insérer 4 piles «AA» dans le boîtier des piles de réception comme indiqué. Vérifier attentivement la polarité des piles (côtés + et -). Connecter ensuite le boîtier sur la prise de l'interrupteur dans le logement radio. Le noir sur le noir et le rouge sur le rouge. Replacer le capot du logement radio.

Conseil :

Utiliser des batteries rechargeables. Elles durent plus longtemps et sont plus économiques à long terme. Remplacer les 4 piles par un pack de batteries 6 V Ni-MH 1100 mAh (Réf. 50 060 8036 JR).

Illustration 1



d. Test de fonction

Toujours allumer l'émetteur avant le modèle. Il est maintenant possible de mettre la voiture sous tension à l'aide de l'interrupteur placé sur le logement radio. Remarque : Toujours vérifier les réglages de la radio-commande avant d'utiliser la voiture !

Vérifier que les roues du modèle sont droites. Dans le cas contraire, utiliser le bouton ST-TRIM placé à droite du volant sur l'émetteur. En le tournant vers la gauche, la voiture tournera aussi vers la gauche. Inversement pour la droite.

Régler maintenant la position neutre des gaz. Retirer le filtre à air du carburateur.

L'ouverture du tiroir de carburateur doit être comprise entre 1 et 1,5 mm pour que le moteur tourne au ralenti. Si l'ouverture est plus importante, le moteur tournera à un régime trop élevé sans freinage. Ceci entraînera un mauvais freinage et une usure prématurée des garnitures de frein rendant le modèle difficile à piloter.

Si nécessaire, utiliser la commande TH-TRIM pour placer le palonnier du servo en position neutre. Dans cette position, les garnitures de frein ne doivent pas être en contact. Ajuster la position des bagues d'arrêt sur la direction avec la clé de 1,5 mm. Replacer ensuite le filtre à air quand les réglages sont satisfaisants.

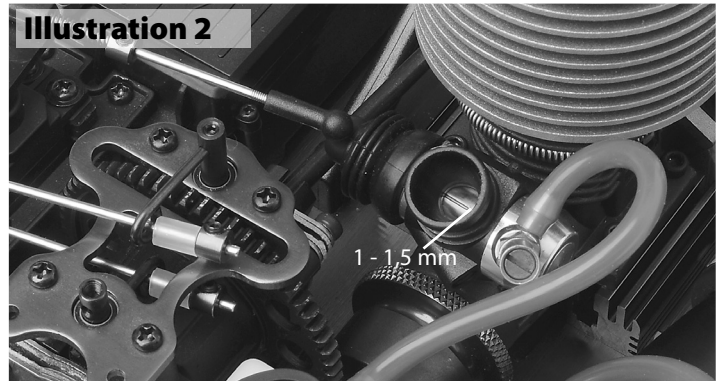

F

e. Ultimes préparations

Assembler la pissette de carburant. La presser et insérer le bec dans un bidon de carburant Nitro. Relâcher lentement la pression pour permettre le remplissage de la pissette. Presser ensuite lentement la pissette pour remplir le réservoir de la voiture.

Conseil 1:

Le carburant conservera ses qualités plus longtemps s'il est entreposé dans un endroit frais, sec et obscur.

Conseil 2:

Ne jamais laisser le chauffe-bougie plus de 10 secondes sur le moteur sous peine de griller le filament de la bougie prématurément. Utiliser de préférence un chauffe-bougie rechargeable.

Conseil 3:

Porter des gants ignifuges pour le démarrage !

f. Mise en route

Le rodage du moteur est l'étape la plus importante pour s'assurer d'obtenir les meilleures performances et une grande fiabilité. NE PAS OUBLIER CETTE ETAPE !

Le moteur est préréglé en usine pour le rodage. Utiliser un support et poser la voiture pour que les roues tournent librement et ne touchent pas le sol.

Avec l'émetteur sous tension, vérifier que les gaz sont au neutre. Placer le chauffe-bougie sur le moteur et tirer le lanceur d'un coup sec (illustration 4). Ne pas le tirer de plus de 25 cm sous peine de casser la corde. Il est préférable d'effectuer plusieurs petites tractions qu'une grande. Si la corde du lanceur se coince, tourner légèrement le plateau avec les doigts. Ceci permettra à la corde de s'enrouler automatiquement. Après quelques tractions, le moteur doit démarrer en émettant un peu de fumée.

F

Illustration 4



Si le moteur ne tourne pas correctement au ralenti à cause du réglage de la richesse, visser la vis de ralenti par pas d'1/8 de tour. Ceci permettra d'augmenter le ralenti et d'effectuer un rodage correct du moteur. Cette étape du rodage doit être effectuée dans un endroit bien aéré. Du pétrole non brûlé du carburant peut s'accumuler au niveau de l'échappement, disposer quelque chose en dessous. Répéter cette étape sur 2 ou 3 réservoirs complets en vérifiant la température du moteur toutes les 2 minutes. Faire une pause de 10 - 15 minutes entre deux réservoirs pleins. On doit pouvoir toucher la culasse du moteur sans se brûler. (Attention ! Ne pas toucher !) Si elle chauffe trop, dévisser (sens trigonométrique) le pointeau et le contre pointeau d'1/8 de tour. Toujours procéder par petits incréments pour effectuer ces réglages.

Conseil:

Réglage d'usine de carburateur : avec le réglage suivant, le moteur démarre immédiatement, évolue parfaitement et est assez riche pour une bonne lubrification (température extérieure de 8°C).

- Vis de butée carburateur : Ouverture du tiroir au ralenti d'environ 1 mm.
- Pointeau principal : pointeau fermé complètement puis ouvrir de 4 tours.
- Pointeau de reprise : le pointeau doit affleurer la commande, visser ensuite d'un tour dans le sens des aiguilles d'une montre.

Illustration 5

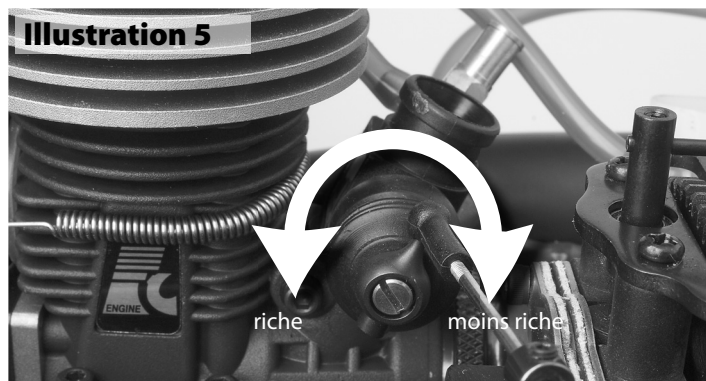
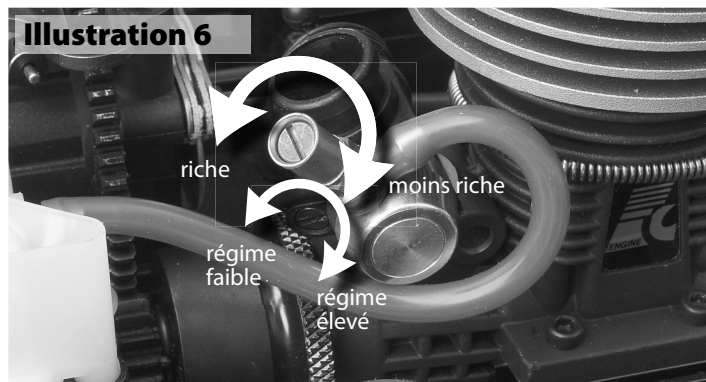

Illustration 6



Après le rodage, resserrer le pointeau principal : il doit alors être ouvert de 3 tours 1/4. Si la température extérieure est importante, la carburation doit être plus riche, ouvrir légèrement le pointeau principal.

Conseil:

Après le rodage, maintenir le réglage du mélange un peu plus riche que la normale et éviter de rester trop longtemps en position plein gaz. Réduire ensuite le mélange par pas d'1/8 de tour. Le régime du ralenti augmentera à mesure que le mélange s'appauvrit.

g. Allumer l'émetteur

Sortir complètement l'antenne de l'émetteur. La portée de la radiocommande est diminuée lorsque l'antenne n'est pas sortie complètement.

ATTENTION !

Toujours allumer l'émetteur en premier !



Interrupteur sur le récepteur

- Interrupteur sur le boîtier de réception.
- Fixer l'antenne du récepteur et le fil (voir p. 73).
- Monter la carrosserie et la fixer à l'aide des goupilles fendues.

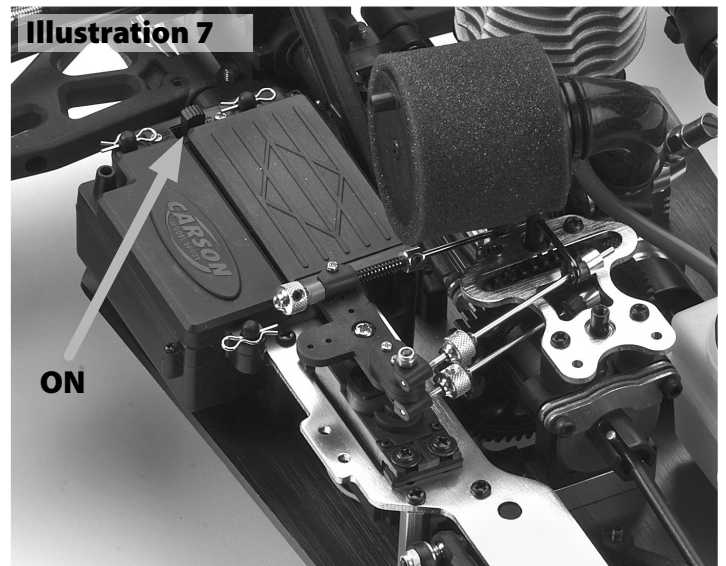

h. Conduite de la voiture

- Soulever les pneus du sol.
- Tourner le volant à droite et à gauche jusqu'en butée. Les roues doivent suivre le sens de rotation du volant.
- Si les roues tournent dans l'autre sens, actionner le commutateur d'inversion (ST en position REV).
- Pour régler la vitesse, actionnez le levier des gaz/du frein
 - vers l'arrière (marche avant, accélération) ou
 - vers l'avant (freinage, marche arrière).



i. Entretien et maintenance

L'absence de rodage et/ou des dommages causés par une utilisation incorrecte annulent la garantie.

Il existe deux moyens pour surveiller la température du moteur. La première solution est d'acheter un capteur de température. La seconde solution, plus économique, est de mettre un peu d'eau (salive) sur la culasse et de vérifier qu'elle ne bout qu'au bout de 3 ou 4 secondes (Le point d'ébullition de l'eau est normalement 100 °C.). Si elle s'évapore immédiatement, le moteur est trop chaud.

Le moteur fonctionne mieux et il est plus facile à démarrer quand sa température de fonctionnement est de 100 - 125 °C. Suivant les conditions météorologiques il peut être nécessaire de modifier les réglages du carburateur. Agir sur les réglages par petits incréments afin de protéger la longévité du moteur. Un mélange trop pauvre ou l'environnement peut provoquer une surchauffe. Une surchauffe excessive peut endommager des composants du moteur.

De nombreux conseils et informations en ligne vous aident à régler le moteur. Les moteurs 3,5 cm³ ont une très longue durée de vie. Avec une maintenance et un réglage correct, le modèle réduit peut être utilisé pendant des heures sans interruption.

Fin de l'utilisation

Quand vous avez fini de piloter votre modèle, il existe deux façons d'arrêter le moteur. La première méthode est d'obturer la sortie de l'échappement. Vérifier que le moteur est au ralenti, de préférence avec les freins serrés.

La seconde méthode consiste à pincer l'arrivée d'air au niveau de l'admission. Ne pas pincer l'arrivée de carburant sous peine de causer une surchauffe !

Il est possible de laisser le carburant restant alimenter le moteur jusqu'à la panne sèche. Le moteur tournera au ralenti jusqu'à son arrêt complet sans avoir à appliquer une des méthodes décrites ci-dessus.

Illustration 8



Mettre un peu d'huile de stockage dans le carburateur et tirer le starter plusieurs fois pour répandre cette huile dans tout le moteur. Ceci est recommandé pour stocker la voiture pour plus d'une journée. Les vapeurs de méthanol produisent de l'eau préjudiciable aux parties internes du moteur. Il est également conseillé de vérifier la présence et le serrage de toutes les vis et écrous avant et après chaque utilisation.

Illustration 9



Maintenir le modèle le plus propre possible pour pouvoir en profiter longtemps. Pour cela, utiliser un pinceau ou une soufflette. Toujours vérifier les batteries d'émission et de réception avant de démarrer la voiture.

Conseil:

Le port des gants est conseillé quand la voiture est chaude!

J. Élimination de pannes

Il est conseillé de lire ces informations avant la survenue de la première panne !

Le moteur ne démarre pas

Moteur noyé. Trop de carburant dans le moteur	Retirer la bougie. Tirer le lanceur 6 à 8 fois. Se méfier des projections de carburant.	Réservoir vide/ Moteur non alimenté	Remplir le réservoir. Amorcer le moteur en tirant sur le lanceur tout en bouchant la sortie d'échappement.
Bougie morte	Retirer la bougie et la placer sur le chauffe bougie. Si le filament est noir, la bougie est morte. S'il est orange, la bougie est bonne.	Surchauffe	Une utilisation à trop haute température peut causer un serrage du moteur. Laisser refroidir 5 à 10 minutes.
Batterie du chauffe bougie morte	Placer une bougie sur le chauffe bougie. Si elle s'éclaire faiblement ou pas du tout, remplacer ou recharger la batterie du chauffe bougie.		

Le moteur cale

Surchauffe	Vérifier la température. Si elle dépasse 130 °C, enrichir le mélange. Vérifier que les roues tournent librement.	Filtre à air encrassé	Laver la mousse avec de l'eau savonneuse et l'imbiber d'huile spéciale (N° 50 003 2648).
Pressurisation carburant déconnectée	Reconnecter la durite entre l'échappement et le réservoir.	Carburateur bouge	Vérifier la clavette et l'écrou de fixation. Presser le carburateur sur le moteur et serrer l'écrou pour éviter l'entrée d'air.

Difficultés pour contrôler le véhicule

Batteries mortes / vides	La batterie de l'émetteur doit être entièrement chargée. Des servos lents indiquent que la batterie de réception est vide.	Course pas droite	Réglage de direction défectueux Boulons des roues avant et arrière desserrés
Réglage de l'émetteur incorrect	Se reporter à la notice de l'émetteur	Ne s'arrête pas	Réglage des gaz défectueux
La voiture ne bouge pas	L'émetteur ou l'interrupteur du châssis sont à l'arrêt Mauvaise polarité ou mauvais type des batteries Batteries déchargées	Voiture trop lente	Perte de puissance du moteur Boulons des roues arrière desserrés Poussière ou corps étrangers dans la transmission

Estimado cliente

Le felicitamos por la adquisición de su coche radio controlado CARSON, que ha sido fabricado con tecnología de actualidad.

De acuerdo con nuestra política de constante desarrollo y mejora de nuestros productos, nos reservamos el derecho de efectuar cambios en las especificaciones relativas a equipo, material y diseño de este producto en cualquier momento sin noticia previa.

Las especificaciones o diseños del producto real podrían variar de los mostrados en el manual o envase.

Este manual es componente del producto. No cumplir las instrucciones operativas y de seguridad incluidas invalidará la garantía. Conserve esta guía como recordatorio o para caso de pasar el modelo a una tercera persona.

Condiciones de la garantía

Este producto está garantizado por CARSON contra defectos de fabricación en materiales o mano de obra bajo utilización normal por un período de 24 meses desde la fecha de adquisición en comercios autorizados. En caso de defecto del producto durante el período de garantía, lleve el producto y el ticket o recibo de venta como prueba de adquisición a cualquier tienda autorizada CARSON.

CARSON podrá a su elección y salvo que las leyes dispongan otra cosa:

- (a) Corregir el defecto mediante la reparación del producto sin cargo de piezas o mano de obra;
- (b) Reemplazar el producto por otro del mismo o similar diseño; o
- (c) Devolver el importe de adquisición del producto.

Todas las piezas y productos reemplazados, así como los productos cuyo importe haya sido devuelto, pasan a ser propiedad de CARSON. Se podrán utilizar piezas nuevas o reacondicionadas para la prestación del servicio de garantía.

Las piezas y productos reparados o reemplazados estarán garantizados por el período restante al vencimiento de la garantía. Cualquier reparación o sustitución del producto tras vencer el período de garantía será abonada por usted.

Esta garantía no cubre:

- Daños o fallos causados o atribuibles a fuerzas de la naturaleza, abuso, accidente, uso incorrecto, impropio o anormal, falta de seguimiento de las instrucciones, mantenimiento o instalaciones inadecuadas, alteraciones, tormentas eléctricas u otros incidentes causados por exceso de voltaje o corriente;
- Todos los daños causados por la pérdida del control del modelo;
- Cualquier reparación no efectuada por un servicio de reparaciones autorizado CARSON;
- Consumibles como fusibles o baterías;
- Daños estéticos;
- Transportes, embarques y / o costos de seguros; o
- Costos de retirada del producto, instalaciones, servicio de ajuste o reinstalación.

Esta garantía le da a usted derechos legales específicos, y usted también podría tener otros derechos que variarían de estado en estado.

Declaración de conformidad

Dickie-Tamiya GmbH & Co. KG por la presente declara que este kit de modelo con radio, motor, batería y cargador está en concordancia con los requerimientos básicos 98/37EG y 89/336/EWG y otras normas pertinentes de la directiva 1999/5/EG (R&TTE).

La declaración de conformidad original se puede solicitar a:

Dickie-Tamiya GmbH & Co. KG • Werkstraße 1 • D-90765 Fürth • Alemania

El producto que ha adquirido está propulsado por una batería recargable Ni-MH. La batería es reciclable. Al final de su vida útil, bajo varias leyes nacionales / estatales y locales, puede ser ilegal tirar esta batería en los contenedores de basura normal. Pregunte a las autoridades locales responsables sobre las opciones adecuadas de reciclado o deshecho.



Significado del símbolo en el producto, el embalaje o las instrucciones de uso. ¡Los electrodomésticos son objetos de valor y, al final de su vida útil, no deben tirarse a la basura doméstica! Contribuya a proteger el medioambiente y los recursos entregando este aparato en los puntos de reciclaje correspondientes. La organización responsable de la recogida de basura o su establecimiento especializado podrán responder a sus preguntas.

¡Le deseamos buena suerte y mucha diversión conduciendo su coche radio controlado CARSON!

¡Antes de utilizar su nuevo modelo lea estas instrucciones cuidadosamente!

Índice de contenidos

Prólogo.....	38
Contenido del kit.....	39
Precauciones de seguridad.....	40
Artículos adicionales necesarios para el arranque del motor.....	42
Herramientas necesarias para el montaje.....	43
a. Su equipo de radio.....	43
b. Chasis.....	44
c. ¡Enchúfelo!.....	44
d. Probando 1...2...3.....	45
e. Últimos preparativos.....	45
f. ¡Momento de divertirse... casi!.....	46
g. Conecte la emisora.....	47
h. Volante de dirección.....	47
i. Mantenimiento y cuidados.....	48
j. Guía de problemas.....	49
Montaje.....	61
Tornillos.....	81
Recambios.....	82
Piezas opcionales.....	87
3,5 cm ³ Motor.....	89
Force 25R – 4,01 cm ³ motor.....	91
Force 32 – 5,23 cm ³ motor.....	93
Setup Sheet.....	95

Contenido del kit



Emisora
(incluido en la versión
sólo RTR)

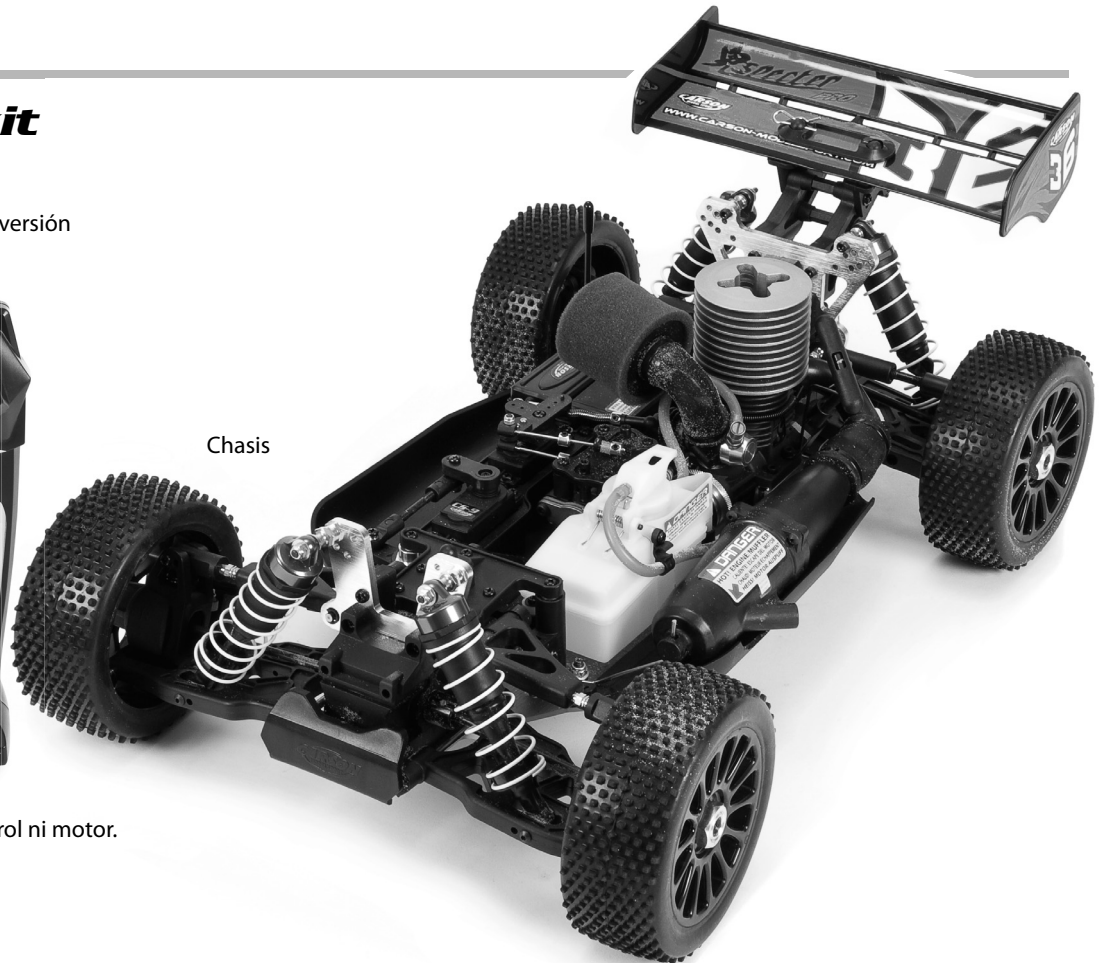

Chasis

La versión en kit no incluye radiocontrol ni motor.

Precauciones de seguridad

Precauciones de seguridad y normas de operativa

Este modelo radio controlado solo debe ser utilizado con el combustible de modelismo adecuado. Evite siempre utilizar modelos radio controlados en áreas restringidas, reducidas o pobladas. Manténgalo alejado de carreteras, autopistas gente y animales. Nunca utilice el modelo en interiores.

Con un automodelo RC de combustión no se deben transportar mercancías, personas ni animales.

¡Por favor, cerciórese de haber leído todas las instrucciones de seguridad y procedimientos de operativa antes de utilizar el modelo!

La carrocería debería estar correctamente fijada al chasis antes de conducirlo.

Permita cierto tiempo para que el escape y el motor se enfríen antes de quitar la carrocería. Estas piezas están extremadamente calientes durante el uso y podrían causar heridas serias.

El modelo no debe utilizarse de forma permanente en las proximidades inmediatas de personas, ya que bajo ciertas circunstancias pueden causarse daños auditivos.

Para evitar que el modelo sufra averías en el sistema de mando y que debido a ello funcione de manera incontrolada, se deberá comprobar que las pilas del emisor y del receptor están en perfecto estado de carga.

Compruebe siempre que no haya tuercas, tornillos pasadores o componentes sueltos. Ajuste y reapriete si fuese necesario.

Llene el depósito de combustible y cierre firmemente la tapa. Limpie cualquier vertido de combustible. No deje nunca combustible en el depósito.

E

¡Este modelo no es un juguete!

- Los modelos radio controlados no son juguetes, su manejo debe ser aprendido paso a paso.
- Los niños menores de 14 años sólo deberían manejar este modelo bajo supervisión adulta.

La conducción de coches radio controlados es un fascinante hobby que debe ser practicado con la necesaria precaución y respeto. Un coche radio-controlado que tiene un peso considerable y capaz de desarrollar velocidades muy altas puede causar daños y lesiones en caso de conducción incontrolada, siendo el usuario legalmente responsable de ello.

Compruebe que dispone de un seguro con la suficiente cobertura contra los daños que pueda causar cuando practique su hobby. Sólo un vehículo montado correctamente funcionará y reaccionará de la manera esperada.

Nunca improvise en las reparaciones y utilice únicamente los recambios originales si fuese necesario. Igualmente y ante un modelo premontado, deberá repasar todas las conexiones y tortillería para asegurarse que están correctamente apretados ajustados.

Nunca comience a conducir sin haberse asegurado de los siguientes puntos:

- Las baterías de la emisora y del receptor dan buen voltaje y no están deterioradas o desgastadas.
- Compruebe antes del arranque el alcance de la radiofrecuencia.
- Compruebe siempre el funcionamiento del sistema de radio antes de utilizar el coche.
- Todos los componentes operativos están en buenas condiciones y se ha comprobado su correcto funcionamiento.
- Verificado que todos los tornillos estén correctamente apretados.
- No hay ninguna otra emisora R/C o similar cercana que pueda causar interferencias. La emisora y el receptor están conectados, y se ha comprobado el buen funcionamiento de todas sus funciones. Primero conecte la emisora, luego el receptor. Invierta el procedimiento para la desconexión. Asegúrese que nadie más está operando en la misma frecuencia que su radio y que no se aprecian interferencias.
- Extienda completamente la antena de la emisora. Asegúrese que nadie más está operando en la misma frecuencia que su radio y que no se aprecian interferencias. Siempre apague el motor y desconecte el coche antes de desconectar la emisora.
- ¡No conduzca bajo líneas de alta tensión, radio mástiles o durante tormentas eléctricas!
- Las perturbaciones atmosféricas pueden afectar las señales de su emisora de radio.
- Las conexiones eléctricas de su modelo no son estancas. En consecuencia, no lo maneje en lluvia, nieve, charcos o hierba húmeda.
- El terreno en el que se pretende operar el modelo no está abierto al tráfico y
- No es usado por personas o animales.
- No conduzca si está muy cansado o su poder de reacción está limitado de algún modo.
- Mantenga siempre contacto visual con el modelo.
- La carrocería debería estar correctamente fijada al chasis antes de conducirlo.
- Un mantenimiento y cuidado periódicos son necesarios para una potencia de marcha de primera clase.
- Estas piezas están extremadamente calientes durante el uso y podrían causar heridas serias, p, ej. la parte superior del motor, el sistema de escape, el engranaje de metal y mucho más. Tocar estas piezas durante el funcionamiento puede provocar lesiones.

Preste atención a las instrucciones de carga de su emisora.

- Asegúrese que las baterías de la emisora y el receptor están completamente cargadas y tienen el voltaje correcto.
 - Con baterías medio gastadas podría perder el control de su modelo.
 - Nunca utilice baterías recargables o de diferente capacidad. Nunca intente recargar las baterías.
- Si no utiliza el modelo por algún tiempo, la batería recargable debe ser retirada.

E

Por favor, lea los siguientes puntos relativos al combustible:

- Mantenga el combustible en un sitio seguro y fuera del alcance de niños o animales.
- Asegúrese que el recipiente del combustible está bien cerrada y apretada.
- Almacene el combustible en un lugar bien ventilado y sin humedad.
- El combustible glow es extremadamente inflamable. Manténgalo fuera de fuentes de calor, llamas directas, dispositivos eléctricos y baterías. No fume cerca del combustible.
- Evite el contacto con la piel y no lo inhale. Lea las etiquetas de advertencia del bote.

Deshágase de los botes vacíos del modo legalmente estipulado. Nunca tire botes vacíos al fuego.

En caso de accidente o indisposición, acudir inmediatamente al médico (mostrar si es posible la etiqueta del combustible).

Por fin

Lea detenidamente estas instrucciones de uso antes de comenzar cualquier trabajo.

Después de cada uso, todas las piezas importantes así como los conectores deberían ser comprobados. ¡Un simple tornillo suelto puede ser suficiente para dejar al modelo en situación peligrosa! Verifique el coche periódicamente y cambie las piezas defectuosas o gastadas por recambio original .

¡Le deseamos buena suerte y mucha diversión conduciendo su coche radio controlado CARSON!

Artículos adicionales necesarios para el arranque del motor

Chispómetro
50 090 5044



Aceite after run
50 090 5044



Aceite de filtro
50 003 2648



Biberón de combustible
50 001 3330



Combustible

Juego de Nitro
50 090 5072



Se recomienda combustible CARSON

Litros	Nitrometano	Nº	Uso
1,0	10%	50 090 5052	Rodaje/ Principiantes
1,0	16%	50 090 5053	Normal
2,5	16%	50 090 5054	Normal
1,0	25%	50 090 5055	Competición
2,5	25%	50 090 5056	Competición

CARSON-ROSSI Bujía

Nº	Artículo	Motor	Combustible	Temperatura
50 090 5006	Bujía Rossi R2 hot	2 - 3,5 ccm	Sin Nitro	+0° - +15°C
50 090 5007	Bujía Rossi R3 medium	3,5 - 6 ccm	Sin Nitro	-2° - +18°C
50 090 5008	Bujía Rossi R4 cold	6 - 10 ccm	Sin Nitro	-5° - +20°C
50 090 5009	Bujía Rossi R5 extra	3,5 - 10 ccm	10% Nitro	-7° - +22°
50 090 5010	Bujía Rossi R6 cold	universal	10-13% Nitro	+10° - +25°
50 090 5011	Bujía Rossi R7 cold	universal	13-15% Nitro	+15° - +30°
50 090 5012	Bujía Rossi R8 extra cold	universal	13-15% Nitro	+20° - +40°

Para la emisora necesitará 8 baterías AA Alcalinas o recargables.



Herramientas necesarias para el montaje

Cutter de modelismo 30 007 4053

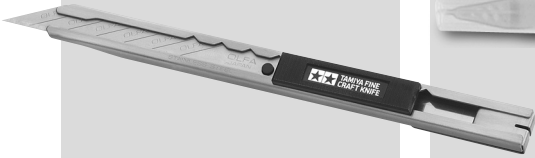

Adhesivo instantáneo 30 005 3339



Alicates de punta fina 30 00 4034



Tijeras 30 001 3305



Destornillador Phillips (pequeño y grande) y Llaves allen 1,5 / 2 / 2,5 mm 30 007 4023

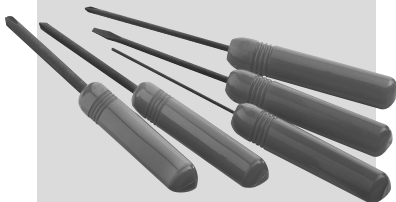

Liave de cruceta 30 001 3118



Pinzas 30 00 4003



Tenacillas 30 00 4035

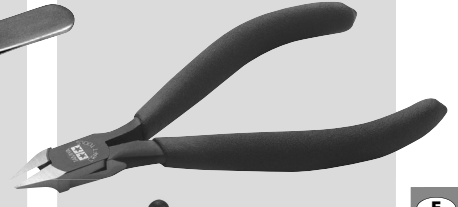

a. Su equipo de radio (sólo en versión RTR)

Por favor, lea las instrucciones facilitadas en su equipo de radio antes de usarlo.

Los servos deben ser centrados en posición neutra antes de comenzar la instalación. Para efectuar el centrado, conecte el emisor y el receptor. Coloque las palancas de los trims en posición central y desconecte el receptor, después el emisor. Los servos estarán ahora en la posición neutra requerida para su instalación.

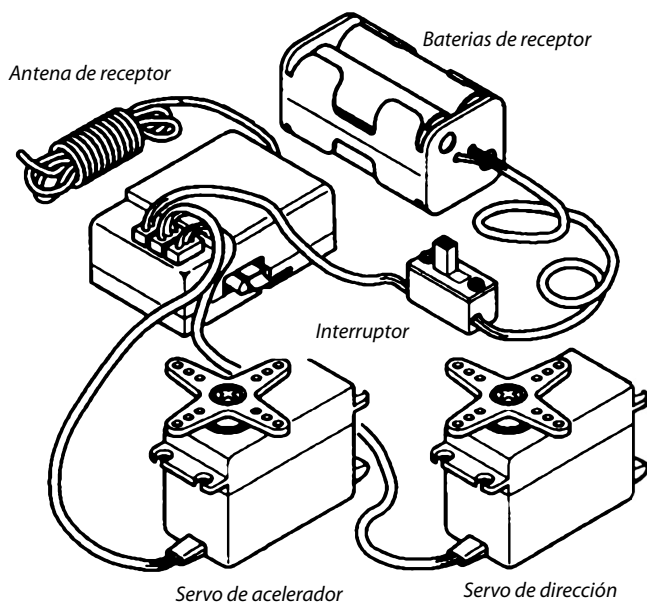

b. Chasis

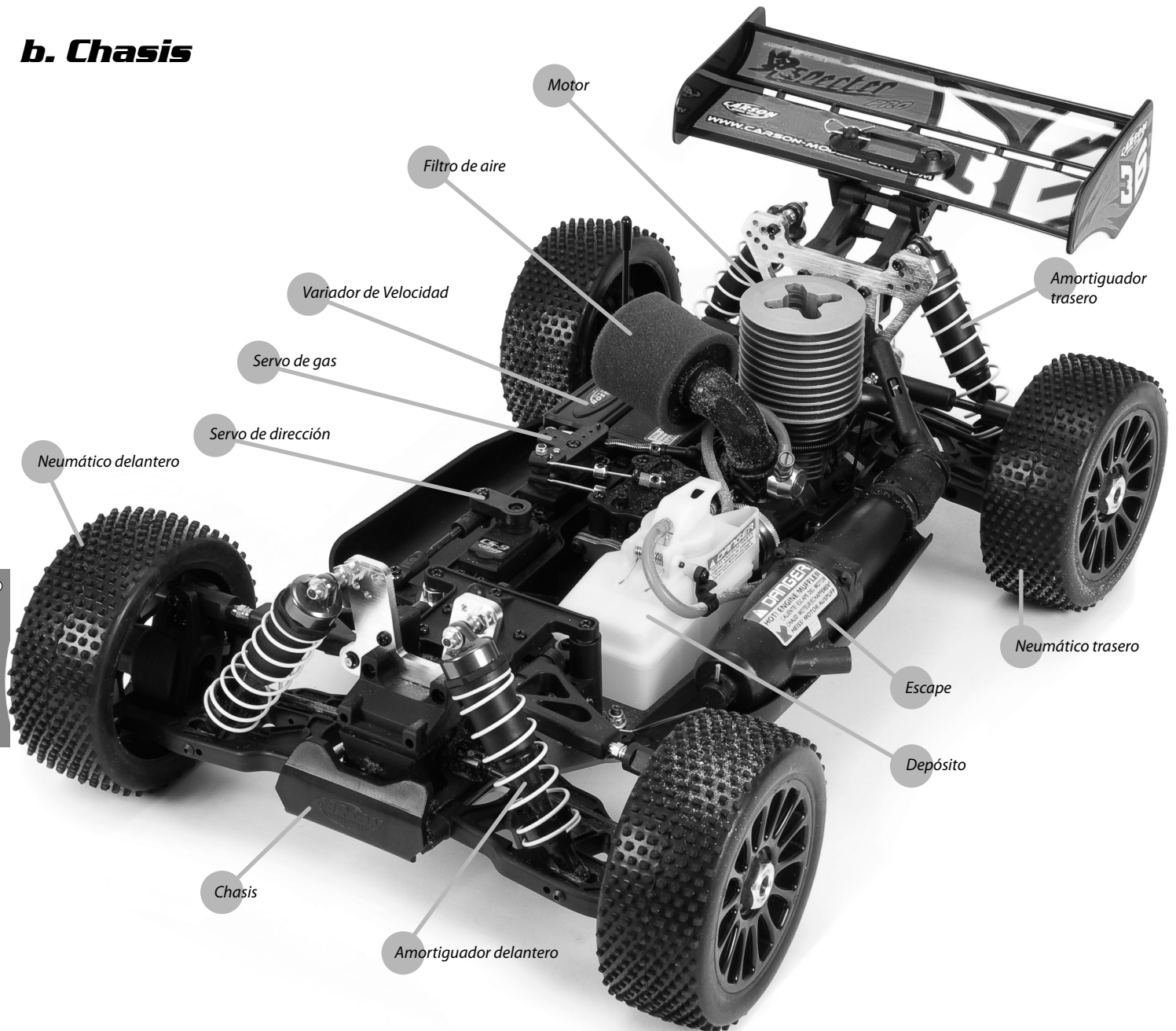

c. ¡Enchúfelo!

Inserte 4 baterías "AA" en el portapilas según se muestra. Asegúrese que los terminales positivo (+) y negativo (-) estén en la posición correcta. A continuación enchufe el portapilas al conector del interruptor, dentro de la caja de radio. El rojo va al rojo y el negro va al negro. Coloque la tapa de la caja de radio.

Consejo:

Utilice baterías recargables. Duran más y las amortizará en poco tiempo. Sustituya el portapilas por nuestro pack 6V NiMh 1100 mAh Akku (Art. 50 060 8036 JR).

Imagen 1



d. Probando 1...2...3...

Siempre conecte primero la emisora antes de conectar el coche. Ahora puede conectar su coche a través del interruptor localizado en la caja de radio. Nota: Compruebe siempre los reglajes de la emisora antes de utilizar el coche.

Asegúrese que la dirección esté centrada. Si no lo estuviese, utilice la palanca del trim de dirección (ST-TRIM) para efectuar el centraje. Girarla hacia la izquierda debería hacer que el coche girase a la izquierda, y viceversa.

Ahora es el momento para regular el acelerador en su posición neutra. Quite el filtro de aire del carburador.

La apertura de la guillotina debería ser muy pequeña, en torno a 1 - 1,5 mm para permitir el ralentí del motor. Si estuviese más abierta, el motor se revolucionará más de lo normal hasta que se apliquen frenos. Esta situación desgastará prematuramente las zapatas de freno y/o embrague, haciendo al coche difícil de conducir.

Utilice la palanca del trim de acelerador (TH-TRIM) para mover el brazo de servo a la posición neutral, si fuese necesario. Cuando esté en neutro, los frenos no deberían quedar ajustados. Ajustando los prisioneros del varillaje con una llave allen de 1,5 mm podrá cambiar los reglajes del freno. Coloque de nuevo el filtro de aire cuando todo quede debidamente ajustado.

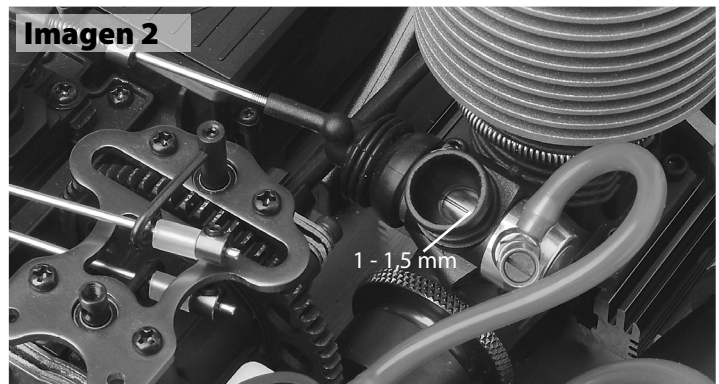

E

e. Últimos preparativos...

Ensamble el biberón de combustible. A continuación apriételo e introdúzcalo en el bote de combustible para coches de automodelismo. Reduzca la presión y el biberón se llenará solo. Después, introduzca y apriete lentamente el biberón para llenar su depósito de combustible.

Consejo 1:

El combustible durará más si lo almacena en un lugar oscuro, fresco y seco. El chispómetro viene junto con el extremo negativo de la parte superior. Enrosque la tapa firmemente.

Consejo 2:

No deje el chispómetro en su motor durante más de diez segundos. Un tiempo superior podría causar que la bujía se fundiese prematuramente. Utilice chispómetros recargables para mayor duración.

Consejo 3:

¡Para arrancar el motor, utilice un guante ignífugo!

f. ¡Momento de divertirse... casi!

El rodaje del motor es el paso más importante para asegurarse que el motor sea rápido y fiable durante su vida útil. Simplemente: **NO SE SALTE ESTE PASO!**

El motor está pre-ajustado de fábrica para el rodaje. Busque un taco de madera o una plataforma y coloque el coche de modo que las ruedas giren libremente sin tocar el suelo.

Asegúrese con la emisora que el acelerador está en la posición neutra. Coloque el chispómetro en la bujía (imagen 4) y dele un tirón al arrancador. ¡No tire más de 25 cm! Más recorrido podría romper la cuerda. Es mejor dar varios tirones cortos que tirones largos. Si la cuerda del arrancador se atasca, gire un poco el volante de inercia con los dedos. Esto debería hacer que la cuerda se enrolle automáticamente. Tras algunos tirones, el motor arrancará con una buena nube de humo.

Imagen 4

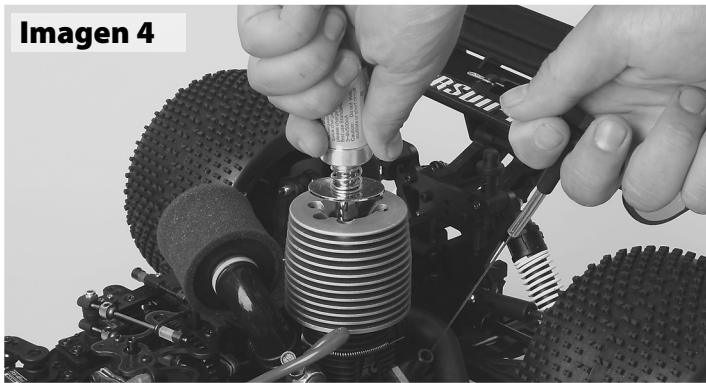

Si el motor tuviese problemas de ralentí con este reglaje "graso", gire el tornillo de ralentí a la derecha 1/8 de vuelta cada vez. Esto aumentará el ralentí permitiendo al motor rodar adecuadamente. Haga esto en un área bien ventilada, por ejemplo en el exterior de su casa. El aceite sin quemar del combustible se acumulará en el escape, así que esté preparado. Deje el coche ralentizar de este modo durante 2 - 3 depósitos, comprobando la temperatura del motor cada dos minutos. Por favor, deje reposar 10 - 15 minutos entre depósito y depósito. Debería poder tocar la culata del motor con los dedos, estando caliente el motor pero sin llegar a quemar. Si parece estar demasiado caliente, "engrase" la carburación (gire a la izquierda) mediante la aguja de altas y la de bajas 1/8 de vuelta. Efectúe siempre pequeños incrementos cuando haga este tipo de reglajes.

Consejo:

Reglaje de fábrica del carburador: Con los siguientes ajustes básicos el motor arranca inmediatamente, funciona limpiamente y suficientemente graso (temperatura exterior 8°C)

- Tornillo de ralentí: Aproximadamente 1 mm de apertura en el barril
- Aguja de altas: Ciérrela completamente, a continuación abra 4 vueltas completas.

Aguja de bajas (en leva de apertura): Enrásela con el borde de la leva, a continuación gire a la derecha una vuelta completa;

Tras finalizar el período de rodaje, la aguja de altas debería quedar abierta al menos 3 y 1/4 vueltas. Un reglaje graso es mejor si la temperatura exterior es alta.

Imagen 5



Imagen 6



Consejo:

Conduzca el coche lentamente con la carburación "grasa" durante algún tiempo tras el rodaje, evitando períodos prolongados a pleno gas. Valla "afinando" gradualmente la mezcla 1/8 de vuelta cada vez. El ralentí aumentará en la medida que valla afinando el motor.

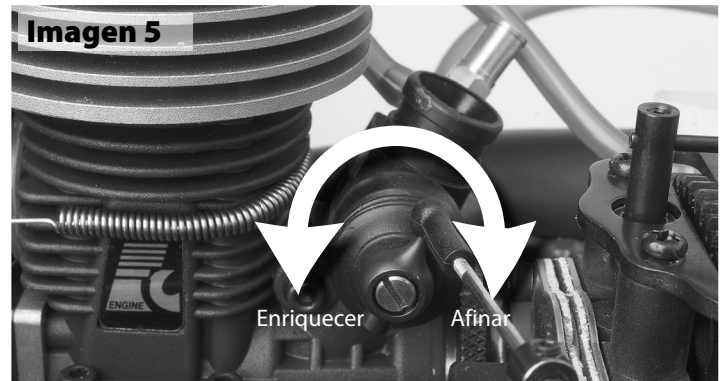
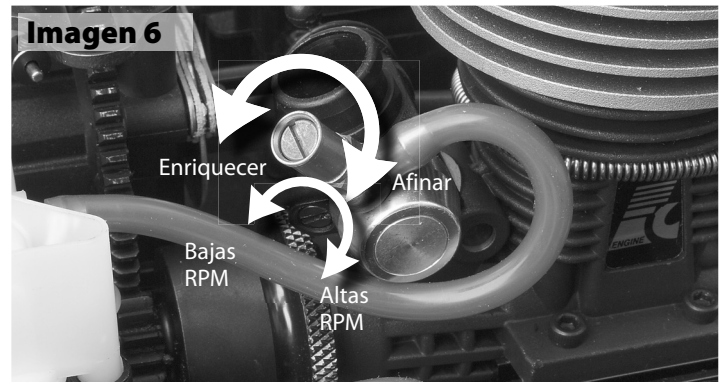
g. Conecte la emisora

Extienda completamente la antena de la emisora.

El radio de acción de la emisora se reducirá si la antena no está completamente desplegada.

¡PRECAUCION!

¡Conecte siempre primero la emisora!



Conecte el receptor

- El interruptor está en la caja de radio.
- Fije el cable de la antena del receptor (ver página 73)
- Coloque la carrocería y fíjela con los clips de carrocería.

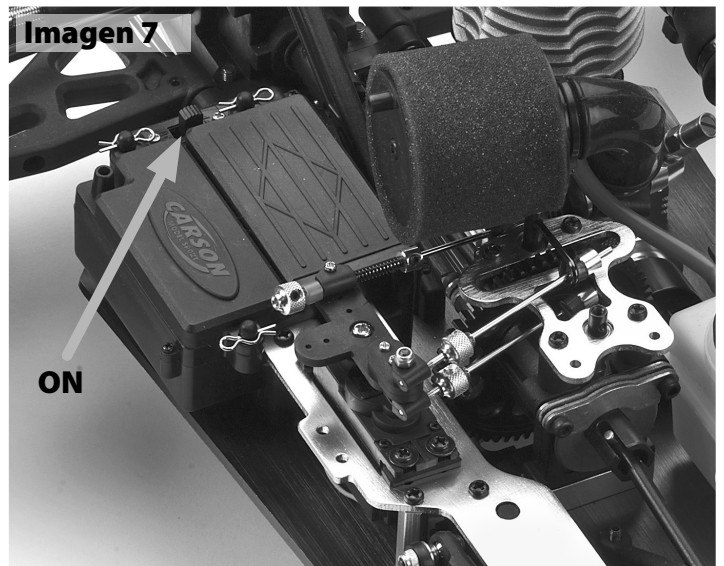

h. Volante de dirección

- Levante las ruedas del suelo y compruebe que todos los controles responden.
- Gire el volante de dirección a derecha e izquierda a su máximo recorrido. Las ruedas deberían seguir el giro del volante.
- Si las ruedas giran en sentido contrario, utilice el interruptor inversor de servo (ST en posición REV).
- Para regular la velocidad presione el gatillo
 - conduciendo hacia delante, para ganar velocidad o
 - empújelo (frenos, marcha atrás).



i. Mantenimiento y cuidados

La falta de seguimiento del período de rodaje y/o daños causados por modificaciones inadecuadas invalidará la garantía de su motor.

Hay dos métodos para comprobar la temperatura del motor. Uno, adquirir una sonda de temperatura. El otro método, más barato pero menos preciso es el „test de saliva“. Ponga un poco de saliva en la culata, ésta debería evaporarse en 3 – 4 segundos (el punto de ebullición del agua es normalmente 100°C). Si se evapora inmediatamente, hay probabilidades que el motor esté funcionando demasiado caliente.

El motor funcionará mejor y será más fácil de arrancar en caliente si funciona entre 100 – 125 °C. Dependiendo de las condiciones ambientales, densidad del aire y humedad, los ajustes de la carburación variarán en el momento de cada utilización. Efectuar ajustes en pequeños incrementos es el mejor método para asegurarse que su motor durará largo tiempo. El sobrecalentamiento es causado por utilizar el motor demasiado afinado, o con demasiado estrés mecánico causado por su entorno de funcionamiento. El sobrecalentamiento severo generará fallos de las piezas internas del motor.

Existen muchas fuentes de información “online” que le pueden ayudar con los ajustes de su motor. Estos motores están diseñados para durar largo tiempo, y con un adecuado ajuste y mantenimiento, podrá utilizar su modelo durante horas cada vez.

E

Parada

Cuando haya acabado de utilizar el coche, hay dos opciones para parar el motor. El primer método es poner el pulgar en la salida del escape. Asegúrese que el motor se encuentra al ralentí, preferiblemente con los frenos activados.

El segundo método es pinzar la entrada de aire al motor. No pince la entrada de combustible, ya que causaría sobrecalentamiento del motor. Pruebe dejar a que el motor consuma todo el combustible del depósito hasta vaciarlo. El motor se revolucionará cuando se vacíe el depósito, de modo que los dos pasos anteriores no serán necesarios.

Imagen 8

A continuación aplique aceite “after run” a través del carburador, y accione el tirador unas cuantas veces para repartirlo dentro del motor. Esto se recomienda si planea no utilizar el coche durante más de un día. El metanol se evapora en agua, que no es buena para las partes internas del motor. Siempre es buena idea revisar todos los tornillos, tuercas y pasadores antes de cada sesión de uso.

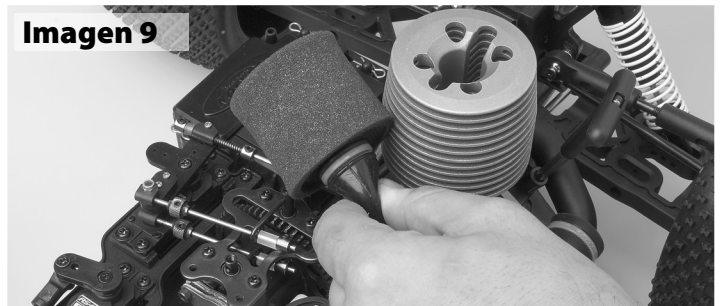
Imagen 9

Mantener el coche limpio hará que sea más agradable trabajar en él. Esto se puede lograr con un compresor grande similar a los utilizados para pintar o con aire comprimido. Compruebe siempre las baterías de la emisora y receptor antes de arrancar el motor.

Consejo:

Utilice guantes cuando trabaje con el coche caliente!

J. Guía de problemas

¡Lea esto antes de que ocurra!

El motor no arranca

Motor ahogado. Mucho combustible en el motor.	Quite la bujía. Accione el tirador 6 – 8 veces. Atención, el combustible puede chorrear.	Depósito de combustible vacío/no hay combustible en el motor.	Llene el depósito. Cebe el motor tirando del arrancador mientras tapa la entrada de aire del carburador.
Cuidado con el combustible pulverizado.	Bujía fundida. Quite la bujía. Colóquela en el chipómetro. Si no prende (oscura), está fundida. Si prende (brillante), está correcta.	Sobrecalentamiento	Rodar a altas temperaturas puede producir bloqueo de vapores en el motor. Déjelo enfriar durante 5 – 10 minutos.
Chispómetro gastado.	Ponga una bujía nueva en el chispómetro. Si brilla muy levemente o no brilla, cambie la batería del chispómetro.		

El motor se para

Sobrecalentamiento	Compruebe la temperatura. Si está por encima de 130°C, enriquezca la mezcla. Compruebe que las ruedas giran libremente.	Filtro de aire sucio	Lávalo con jabón y agua, a continuación utilice aceite de filtro de aire (Nº 50 003 2648).
Toma de presión desconectada	Recoloque el tubo de presión del escape al depósito de combustible.	Carburador suelto	Compruebe el pasador de sujeción del carburador y su tuerca. Presione el carburador contra el bloque de motor y apriete la tuerca para evitar tomas de aire.

Difícil de controlar, interferencias

Baterías gastadas/dañadas	Las baterías de la emisora deberían estar completamente cargadas. La lentitud de funcionamiento de los servos significa baterías de receptor gastadas.	No va recto	El trim de dirección no está correctamente ajustado. Las tuercas de rueda delanteras y trasera están muy sueltas.
Ajuste inadecuado de la emisora	Remítase a las instrucciones de ajuste de su radio.	No para	El trim de acelerador no está correctamente ajustado.
El modelo no se mueve	El interruptor de la emisora o del coche no está conectado. La polaridad o el tipo de batería es incorrecto. Las baterías están gastadas.	Funciona muy lento	El motor ha perdido potencia. Las ruedas están muy sueltas. Han entrado en los engranajes polvo u otros objetos.

Caro Cliente

Ci congratuliamo con lei per l'acquisto di questo modello radio comandato CARSON, che è stato progettato secondo gli ultimi ritrovati della tecnica.

Per mantenere sempre aggiornati i nostri prodotti ci riserviamo il diritto di effettuare qualsiasi aggiornamento tecnico atto a migliorarne le qualità senza alcun preavviso.

Alcune caratteristiche tecniche di questo prodotto possono perciò essere diverse da quelle illustrate in questo manuale o sulla scatola.

Questo manuale fa parte di questo prodotto. In caso che non doveste seguire le istruzioni e le avvertenze di sicurezza riportate in questo manuale scade il diritto di garanzia. Conservate questo manuale per la rilettura e per un'eventuale inoltrare di questo modello a terzi.

Condizioni di Garanzia

Questo prodotto è garantito da CARSON, da difetti di fabbricazione nei materiali e lavorazioni, riscontrati nel normale utilizzo del modello, per 24 mesi dalla data di acquisto presso un rivenditore autorizzato. In caso di prodotto difettoso durante il periodo di garanzia, recarsi con il prodotto e lo scontrino o ricevuta presso qualsiasi rivenditore CARSON.

CARSON a sua discrezione, provvederà in accordo alle normative vigenti:

- (a) Riparare il prodotto senza addebitare nulla;
- (b) Sostituire il prodotto con un altro uguale o di simili caratteristiche, o
- (c) Rimborsare il prezzo di acquisto.

Tutte le parti sostituite o rimborsate diventano di proprietà della CARSON. Nell'ambito delle prestazioni di garanzia possono essere utilizzati elementi nuovi o ritrattati.

Le parti nuove sostituite o riparate possono essere utilizzate per il servizio di garanzia. Le parti riparate o sostituite in garanzia sono a loro volta coperti da garanzia.

Dalla garanzia sono esclusi:

- Danni o guasti causati da eventi naturali, normale usura, abusi, incidenti, utilizzo non corretto, inosservanza delle istruzioni, montaggio non corretto, imperizia dell'utilizzatore, mancanza di manutenzione, fulmini o altri incidenti causati da eccesso di voltaggio;
- Tutti i danni causati dalla perdita di controllo del modello
- Tutte le riparazioni non effettuate da personale autorizzato CARSON
- Le parti di consumo e le batterie
- Danni estetici non funzionali
- Trasporto, spedizione o costi assicurativi
- Costi di ritiro del prodotto, installazioni, regolazioni e reinstallazioni.

La garanzia in ogni caso è applicata in conformità alle vigenti norme nello stato dove il prodotto è stato acquistato.

Dichiarazione di conformità

Dickie-Tamiya GmbH & Co. KG dichiara che questo modello in tutte le sue parti, radio, motore, batteria, caricabatteria, è in regola con le SEGUENTI DIRETTIVE EUROPEE: 98/37EG e 89/336/EWG Inoltre è conforme alle direttive 1999/5/EG (R&TTE).

La dichiarazione originale di conformità può essere richiesta al seguente indirizzo:

Dickie-Tamiya GmbH & Co. KG • Werkstraße 1 • D-90765 Fürth

Il prodotto che avete acquistato è alimentato da batteria ricaricabile al Ni-MH. La batteria è riciclabile. Alla fine del suo ciclo, in diverse nazioni e/o leggi locali, potrebbe essere illegale introdurla nei cassonetti della immondizia. Assicuratevi come procedure per lo smaltimento, con il vostro locale ufficio smaltimento rifiuti.



Significato del simbolo sul prodotto, sulla confezione o nelle istruzioni per l'uso. Gli apparecchi elettrici sono prodotti riciclabili e quindi, al termine del loro ciclo di vita, non devono essere gettati tra i rifiuti domestici! Aiutateci a tutelare l'ambiente e a preservare le risorse, conferendo questo apparecchio presso i relativi centri di raccolta. Se avete domande a questo proposito, vi consigliamo di rivolgervi all'ente responsabile dello smaltimento dei rifiuti o al vostro rivenditore specializzato.

Vi auguriamo buona fortuna e buon divertimento alla guida del vostro modello CARSON.

Prima di utilizzare il vostro nuovo modello leggete attentamente queste istruzioni!

Contenuto

Prefazione	50
Contenuti del kit.....	51
Misure di sicurezza.....	52
Articoli necessari non compresi per la messa in moto del modello	53
Utensili necessari al montaggio del modello.....	54
a. Il suo apparato radio	54
b. Telaio.....	55
c. Alimentazione batterie della ricevente.....	55
d. Controlli	56
e. Preparativi finali.....	56
f. Messa in strada!.....	57
g. Accendere il trasmettitore	58
h. Come controllare il vostro modello	58
i. Servizio e manutenzione.....	59
j. Trattamento dei problemi.....	60
Montaggio	61
Viti.....	81
Ricambi	82
Parti speciali	87
Motore 3,5 cm ³	89
Motore Force 25R – 4,01 cm ³	91
Motore Force 32 – 5,23 cm ³	93
Messa a punto	95

Contenuti del kit



Trasmettitore
(incluso in RTR
versione solo)

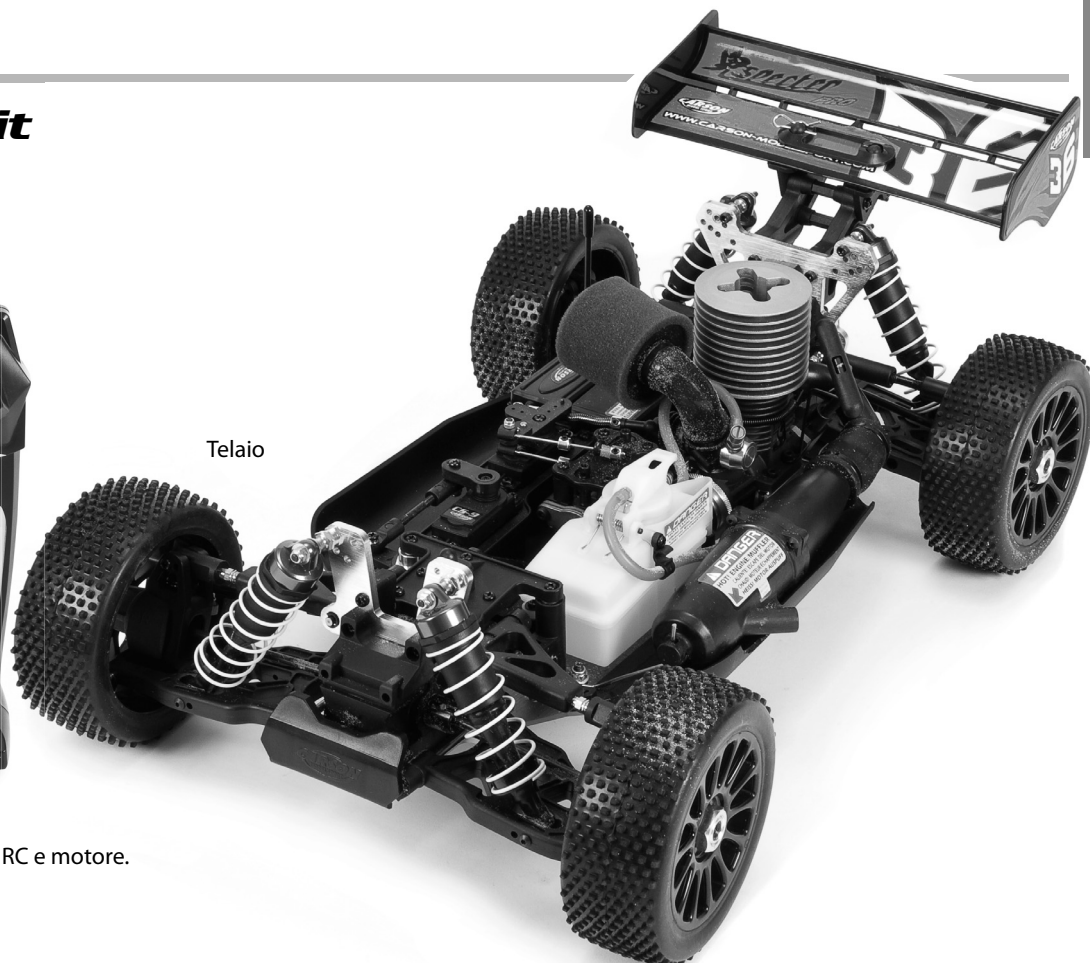

Telaio

Nella versione kit non sono contenuti RC e motore.

Misure di sicurezza

Precauzioni di sicurezza e guida operativa

Questo modello radiocomandato deve utilizzare solo miscela approvata. Evitate sempre di usare il modello in zone vietate, limitate o popolate. State lontani da strade, autostrade, persone ed animali. Non utilizzate mai il modello in luoghi chiusi.

Con l'automodellino radiocomandato a scoppio non è consentito trasportare merci, persone o animali.

Prima di iniziare ad utilizzare il modello leggere attentamente queste istruzioni!

La carrozzeria deve essere ben fissata sul modello prima della messa in moto.

Aspettare che il motore e gli scarichi si siano raffreddati prima di asportare la carrozzeria, queste parti diventano presto caldi e possono causare gravi ustioni.

Non deve essere azionato in modo continuativo nelle immediate vicinanze di persone perché potrebbe causare danni all'udito.

Per evitare guasti del sistema di controllo e la conseguente marcia incontrollata del modellino, controllare che le batterie del trasmettitore e del ricevitore siano perfettamente cariche.

Verificare il serraggio dei dadi e delle viti del modello dopo ogni corsa ed usare se necessario del frena filetti.

Riempire il serbatoio di miscela e chiudere bene il tappo, asciugare la miscela fuoriuscita. Svuotare sempre il serbatoio dopo l'utilizzo.

Questo modello non è un giocattolo!

- I modelli radiocomandati non sono giocattoli, l'utilizzo di essi deve essere imparato passo passo.
- I bambini sotto i 14 anni possono guidare il modello solo sotto la supervisione di un adulto.

Guidare un modello radiocomandato è un affascinante hobby che deve essere praticato con la necessaria cautela e rispetto. Poiché gli automodellini telecomandati hanno un peso considerevole e raggiungono velocità molto elevate, nella marcia incontrollata possono provocare notevoli danni e lesioni dei quali dovrà rispondere l'utilizzatore.

Cautelatevi con una sufficiente copertura assicurativa, che vi consenta di praticare il vostro hobby in assoluta sicurezza. Il vostro modello funzionerà bene solo se sarà tenuto in perfetta efficienza.

Utilizzare solo ricambi originali e non montare mai parti non adatte. La responsabilità del modello è direttamente di chi lo guida, per cui assicurarsi prima dell'utilizzo che tutto funzioni correttamente e che tutta la viteria sia ben stretta.

Non iniziare a guidare prima di avere osservato i seguenti punti:

- Le batterie del trasmettitore e della ricevente siano ben cariche e del corretto voltaggio.
 - Controllare sempre le operazioni radio prima di far partire il modello.
 - Assicuratevi che tutti servocomandi rispondano correttamente al segnale del trasmettitore.
 - Tutte le parti del modello siano in buone condizioni ed assicuratevi della loro funzionalità.
 - Dovete essere sicuri che tutte le viti siano ben strette.
 - Che non ci siano altri modelli o trasmettitori nelle vicinanze che possano causare interferenze. Segnali di disturbo sulla stessa frequenza possono far perdere il controllo del modellino. Accendere sempre prima il trasmettitore per evitare reazioni incontrollate della ricevente o percezione di segnali estranei.
 - Estraete completamente l'antenna ed assicuratevi che nessuno intorno a voi utilizzi la stessa frequenza (numero marcato sul quarzo) e che non ci siano interferenze. Spegnerne sempre prima la ricevente e quindi il trasmettitore.
 - Tenete il vostro modello lontano da cavi di alta tensione o antenne radio. Non usare mai il modello durante temporali con fulmini!
 - I disturbi atmosferici possono influire sui segnali del teletrasmettitore.
 - Il sistema elettrico del modellino non è impermeabile all'acqua. Pertanto non guidare nella pioggia, nella neve, nelle pozzanghere o sull'erba bagnata.
 - Evitate sempre di guidare il modello in zone ristrette e limitate o in aree popolate.
 - State lontani da strade, autostrade, persone e animali!
 - Non guidare se si è stanchi o se le proprie capacità di reazione sono ridotte per altri motivi.
 - Guardare continuamente il modello e non distrarsi.
 - La carrozzeria deve essere fissata correttamente al modello prima dell'utilizzo.
 - Manutenzione e cure periodiche sono necessarie per ottenere delle prestazioni ottimali.
 - Fare raffreddare tutte le componenti del motore prima di rimuovere la carrozzeria. Queste parti durante l'uso diventano estremamente calde e possono causare gravi ustioni.
- Assicurarsi che le batterie siano ben cariche e del corretto voltaggio.
- Quando le batterie si stanno scaricando potreste perdere il controllo del modello.
 - Non mischiare mai nel trasmettitore accumulatori/batterie carichi con accumulatori/batterie semiscarichi o con accumulatori di capacità diversa.
 - Cercare di non caricare mai pile a secco (solo gli accumulatori sono ricaricabili).
- Dopo l'utilizzo rimuovere le batterie dal modello.

Per il carburante rispettare quanto segue:

- Tenere la miscela in un luogo sicuro e fuori dalla portata dei bambini e di animali domestici.
- Assicurarsi che il recipiente sia ben chiuso.
- Tenere la miscela in luogo ben ventilato ed asciutto.
- Il carburante è estremamente infiammabile. Tenerlo lontano da tutte le fonti di calore, da fiamme libere, apparecchi elettrici e batterie. Non fumare nelle immediate vicinanze.
- Evitate di toccare e Assolutamente Non inalare. Leggere attentamente le avvertenze riportate sulla confezione.

Buttare il contenitore vuoto negli appositi bidoni. Non buttare il recipiente anche vuoto sul fuoco.

In caso d'infortunio o di malore, consultare immediatamente un medico (recare possibilmente con sé l'etichetta del carburante).

A fine utilizzo

Leggere attentamente le presenti istruzioni prima di intraprendere qualsiasi operazione.

Dopo ogni utilizzo, verificate sempre che tutte le parti siano in perfetta efficienza, e ricordatevi che un solo particolare difettoso può causare gravi danni alle persone. Controllate periodicamente il vostro modello e sostituite le eventuali parti danneggiate solo con ricambi originali del modello.

Vi auguriamo buona fortuna e buon divertimento con il vostro modello CARSON.

Articoli necessari non compresi per la messa in moto del modello

Accendi candela
50 090 5044



Olio Afterrun
50 090 5044

olio filtro
50 003 2648



Riempitore
50 001 3330



Miscela

Set Nitro
50 090 5072



Miscela CARSON

Litro	Nitrometano	N°	Utilizzo
1,0	10%	50 090 5052	Rodaggio/ principianti
1,0	16%	50 090 5053	Normale
2,5	16%	50 090 5054	Normale
1,0	25%	50 090 5055	Race
2,5	25%	50 090 5056	Race

Candele CARSON-ROSSI

N°	Articolo	Motore	Miscela	Temperature
50 090 5006	Glow plug Rossi R2 hot	2 - 3,5 ccm	senza Nitro	+0° - +15°
50 090 5007	Glow plug Rossi R3 medium	3,5 - 6 ccm	senza Nitro	-2° - +18°
50 090 5008	Glow plug Rossi R4 cold	6 - 10 ccm	senza Nitro	-5° - +20°
50 090 5009	Glow plug Rossi R5 extra	3,5 - 10 ccm	10% Nitro	-7° - +22°
50 090 5010	Glow plug Rossi R6 cold	universal	10-13% Nitro	+10° - +25°
50 090 5011	Glow plug Rossi R7 cold	universal	13-15% Nitro	+15° - +30°
50 090 5012	Glow plug Rossi R8 extra cold	universal	13-15% Nitro	+20° - +40°

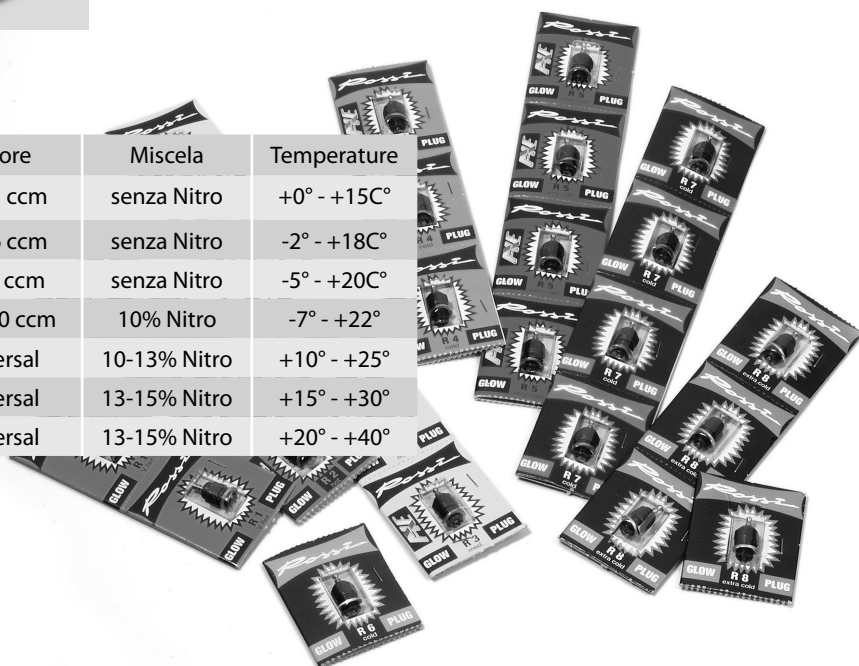

Per la trasmittente necessitano 8 batterie AA Stilo a secco o ricaricabili.

Utensili necessari al montaggio del modello

Cutter 30 007 4053

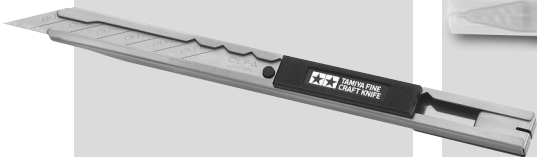

Colla istantanea 30 005 3339



Pinze 30 00 4034



Forbici 30 001 3305



Cacciaviti esagonali mm.
1,5/ 2/ 2,5 mm 30 007 4023

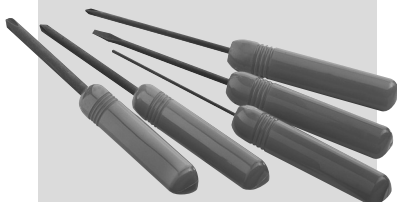

Chiave candela 30 001 3118



Pinzetta 30 00 4003



Tronchesine 30 00 4035

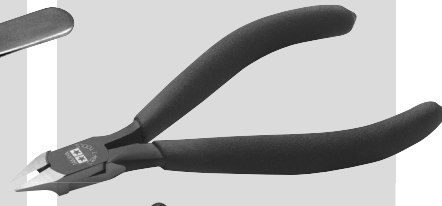

1 a. Il suo apparato radio (Solo nella versione RTR)

Vi preghiamo di leggere le istruzioni del vostro radiocomando prima di usarlo.

I servi debbono essere regolati al centro prima di essere installati. Per regolare una posizione neutra accendere il trasmettitore e la ricevente. Regolare i trims in posizione centrale e spegnere la ricevente. I servi saranno ora regolati al centro e pronti per l'installazione.

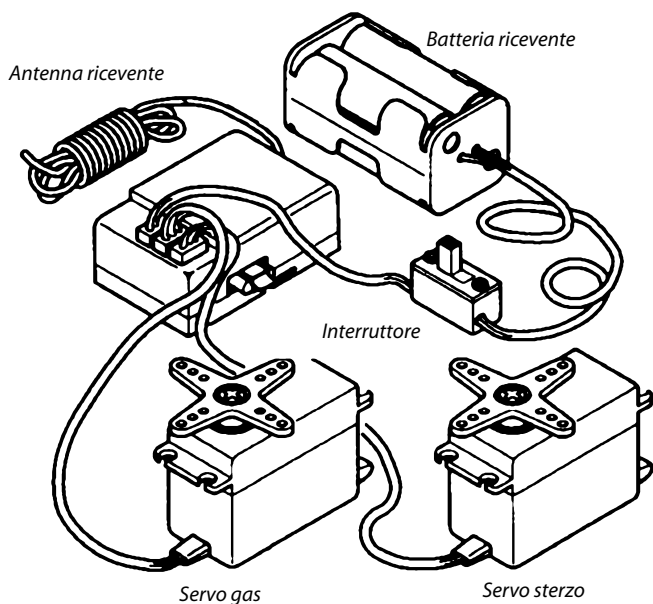

b. Telaio

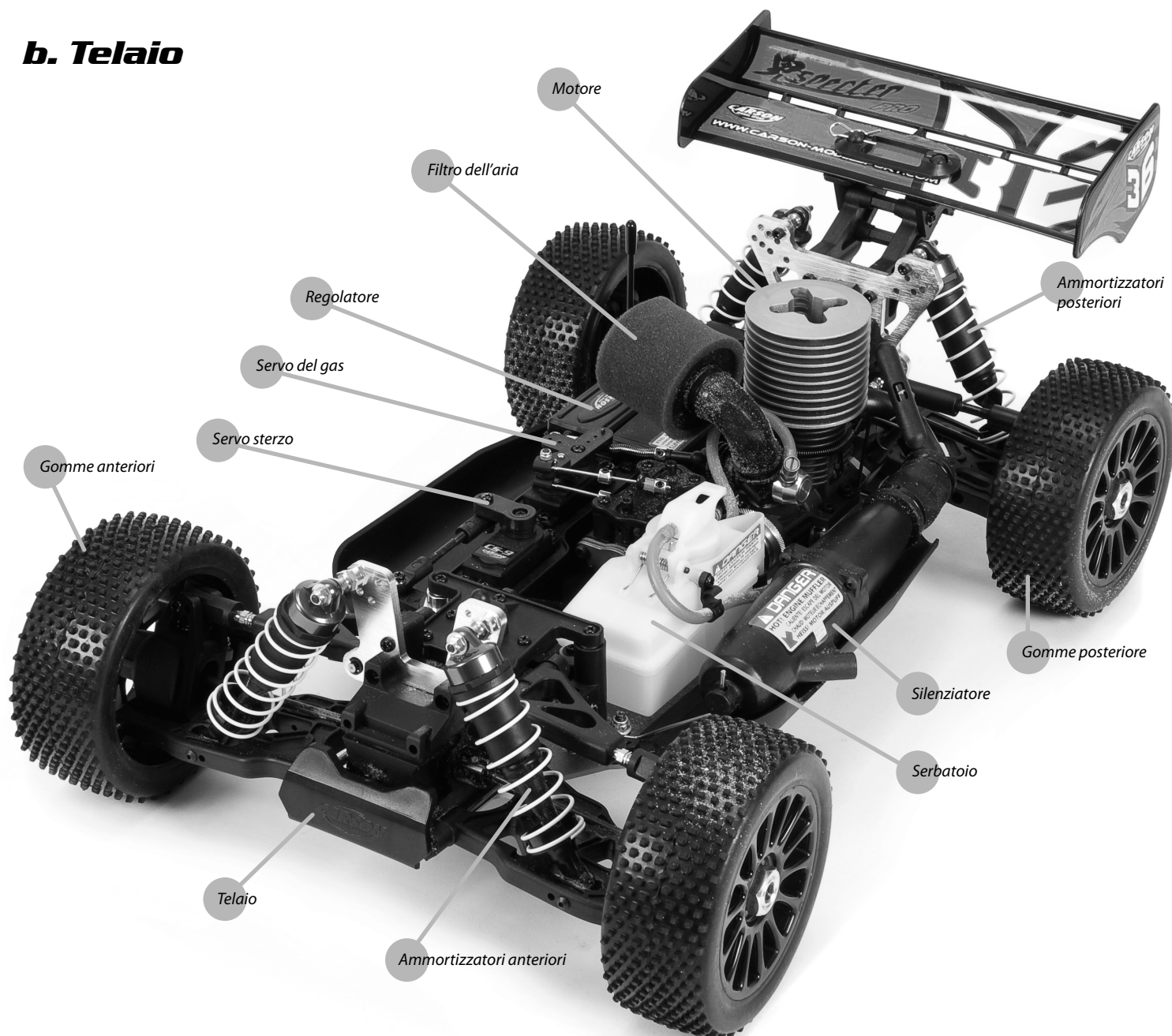

c. Alimentazione batterie della ricevente

Inserire 4 batterie tipo "AA" nel porta batterie della ricevente come da foto. Assicuratevi di posizionare le batterie con la giusta polarità, positivo (+) e negativo (-). Quindi collegate la spinetta della batteria con la spinetta dell'interruttore. Il nero con il nero ed il rosso con il rosso. Riposizionate il vano batterie.

Consiglio:

Utilizzate delle batterie ricaricabili. Hanno una buona durata e si ammortizzeranno in breve tempo. Sostituire il porta pile con il nostro pacco batterie 6 V NiMH 1100 mAH (codice 50 060 8036 JR).

Immagine 1



d. Controlli

Accendere sempre prima il trasmettitore e dopo la ricevente. Ora potete accendere il vostro modello utilizzando l'interruttore on/off posizionato sulla scatola radio. Controllate sempre le regolazioni prima di accendere il modello!

Controllate che lo sterzo sia centrato. Se non lo fosse, usate il pomello ST-TRIM a sinistra del volantino di comando sterzo. Girando il volantino verso sinistra il modello deve girare a sinistra e girando a destra il modello deve andare a destra.

Consiglio: Leggere attentamente il manuale della vostra radio per effettuare le regolazioni avanzate.

Adesso bisogna regolare l'acceleratore in posizione neutra. Rimuovere il filtro dell'aria.

L'apertura della ghigliottina deve essere molto ridotta, da 1 a 1,5 mm per permettere al motore di girare al minimo (immagine 2). Se è molto più aperta il motore rimarrà accelerato anche con il freno azionato, provocando una più rapida usura sia delle pastiglie dei freni che della frizione, creando difficoltà di guida del modello.

Quindi utilizzate se necessaria la regolazione del trim TH-TRIM per mettere il servo in posizione neutra. In questa posizione neutra il freno non deve essere bloccato. Se necessita agite con chiavetta esagonale da 1,5 mm. sul collarino della leva freno. Rimontare il filtro aria quando avete finito le regolazioni.

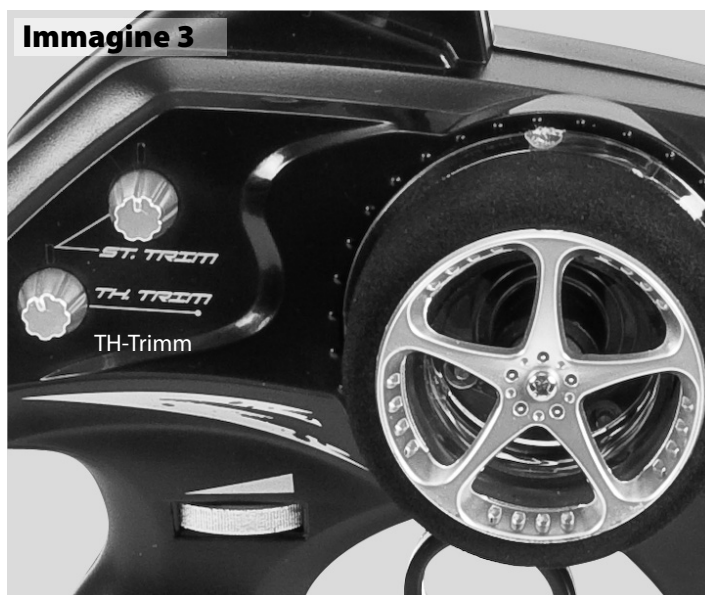

e. Preparativi finali

Assemblare il riempitore miscela. Per riempire di miscela il riempitore, bisogna comprimerlo ed immergerne il beccuccio nel contenitore della miscela. Lasciare decomprimerlo e si riempirà di miscela. Riempite il serbatoio premendo dolcemente sul riempitore ed assicurarsi a fine riempimento che il tappo sia ben chiuso.

Consiglio 1:

La miscela durerà più a lungo se tenuta in luogo fresco, asciutto ed al buio.

Consiglio 2:

Non lasciare più di 10 secondi la pipette candela collegata alla candela. Un tempo superiore né può causare la bruciatura prematura del filamento. Per una maggiore durata utilizzate una pipetta candela ricaricabile.

Consiglio 3:

Per l'avviamento utilizzare appositi guanti ignifughi!

f. Messa in strada!

Un buon rodaggio del motore, assicura buone prestazioni e lunga vita al vostro motore. Assolutamente:
NON SALTATE QUESTA PARTE!

Il motore è già regolato per il rodaggio. Posizionate il modello su un supporto in maniera che le ruote siano libere di muoversi.

Assicuratevi che il gas sia in posizione neutra. Collegare la pipetta candela alla candela (immagine 4) e dare una tirata secca. Non tirate più di 25 cm! Se esagerate si può rompere la corda. E' meglio dare molti strappetti corti che uno ampio, non è una motosega! Se la corda si arrotola, girate con le dita il volano. Questo movimento fa raccogliere la cordicina dello strappo. Dopo poche tirate, il motore si avvierà emettendo abbastanza fumo.



Se il motore regolato così grasso fa fatica a tenere il minimo, girate la regolazione del minimo di 1/8 di giro alla volta in senso orario. Così aumenterete il minimo e farete un buon rodaggio. Effettuate queste operazioni in un'area ben ventilata, magari sul marciapiede di casa. L'olio della miscela non bruciato si depositerà sotto la vostra marmitta. Continuate questo rodaggio per 2/3 serbatoi completi, controllando la temperatura ogni 2 minuti. Aspettate 10/15 minuti da un serbatoio all'altro per permettere al motore di raffreddarsi. Toccando con la punta delle dita la testa del motore, dovrà essere calda, ma non bollente. Se vi sembra troppo calda, ingrassate leggermente girando sempre di 1/8 di giro. Fate sempre delle piccole regolazioni, quando andate intorno alla carburazione.

Consiglio 1:

Regolazioni alla fabbrica del carburatore:

Con queste regolazioni di base già effettuate dalla fabbrica, il motore si avvierà immediatamente e sarà ben regolato, le regolazioni sono effettuate per una temperatura esterna di 8 gradi.

- Vite di arresto ghigliottina: approssimativamente 1 mm. di apertura
- Spillo del massimo: serrarlo completamente e poi aprire di 4 giri completi
- Spillo del minimo: portarlo rasente alla leva del gas e fare un giro completo in senso orario

Dopo avere effettuato il rodaggio l'apertura dello spillo del massimo deve essere ridotta a 3 giri e 1/4. Se le temperature esterne sono più alte usare una carburazione più grassa.

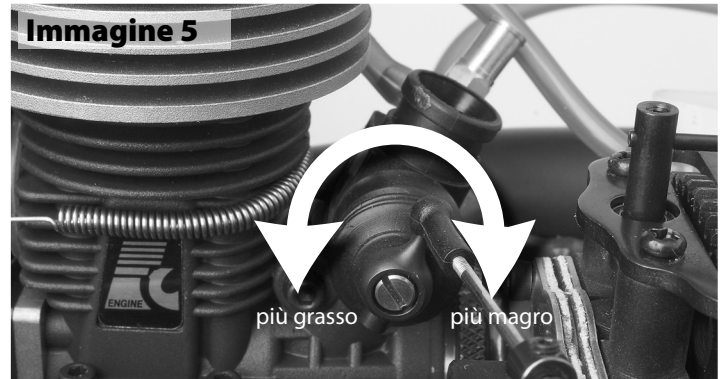

Consiglio 2:

Durante questa fase guidate il modello evitando lunghe accelerazioni. Gradualmente smagrite sempre con piccole regolazioni di 1/8 di giro. Smagrendo il minimo si alzerà.

g. Accendere il trasmettitore

Estrarre l'antenna del trasmettitore completamente.

La gittata del radiocomando si riduce notevolmente se non estraete completamente l'antenna.

ATTENZIONE! Accendere sempre prima il trasmettitore!



Interruttore della ricevente

- L'interruttore della ricevente è dentro la scatola di protezione.
- Inserire l'antenna della ricevente nell'apposita guaina flessibile (vedi pagina 73).
- Montate la carrozzeria e fissatela con le clips in dotazione.

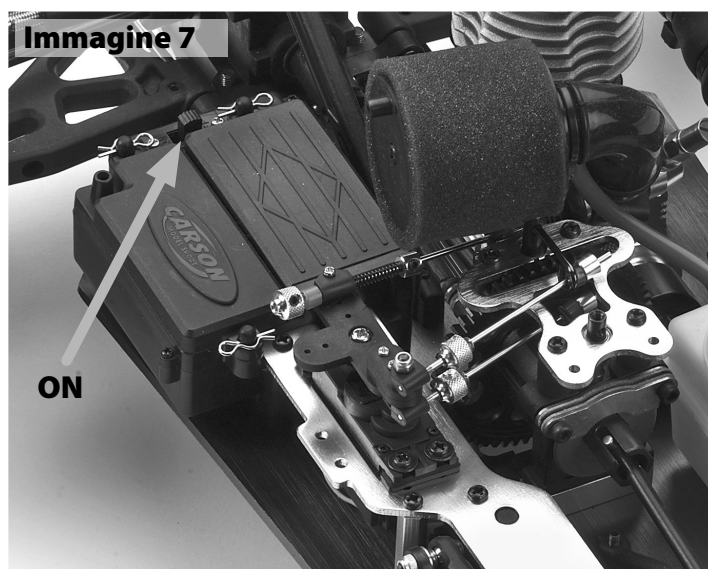

h. Come controllare il vostro modello

- Alzare le gomme da terra e controllare che i comandi rispondano.
- Girate il volantino dello sterzo a destra e a sinistra. Le ruote devono sterzare seguendo i comandi.
- Se le ruote girano in modo inverso, invertite i Reverse del servo (ST in posizione REV).
- Per regolare la velocità agire sulla leva del gas/freno
 - indietro (per andare avanti ed accelerare) e/o
 - in avanti (per frenare o andare in retromarcia).



i. Servizio e manutenzione

La non esecuzione di un buon rodaggio, e/o il danneggiamento causato da parti Tuning invalideranno la garanzia sul motore.

Ci sono 2 metodi per provare la temperatura del vostro motore. Acquistare una sonda termica. La seconda meno costosa, ma anche meno accurata è la tecnica della saliva. Mettere un po' di saliva sulla testa del motore e dovrebbe evaporare in 3/4 secondi (la temperatura di ebollizione dell'acqua è normalmente 100 °C). Se evapora immediatamente può voler dire che il motore sta scaldando troppo.

Il motore gira bene e si riavvia facilmente se non supera i 100/125 gradi di temperatura. A seconda della temperatura, della densità dell'aria, umidità, il carburatore va regolato di conseguenza. Fare delle piccole regolazioni è sempre la cosa migliore, per far durare più a lungo il vostro motore. Il surriscaldamento è causato da una regolazione troppo magra, o da un utilizzo in condizioni critiche. Questo surriscaldamento può danneggiare le parti interne del motore.

Ci sono molti accorgimenti che potete usare per fare durare più a lungo il vostro motore, e potete guidare il vostro modello per molte ore. I motori da 3,5 ccm si contraddistinguono per la durata estremamente lunga e, con una manutenzione e tuning corretti, l'automodello può funzionare per ore senza interruzione.

Fine utilizzo

Per spegnere il motore ci sono 2 sistemi. Il primo metodo è quello di chiudere con un dito lo scarico. Assicuratevi che il motore sia al giusto minimo e con il freno attivato.

Il secondo metodo consiste nel tappare il filtro dell'aria, quindi facendogli mancare ossigeno. Non strozzare mai il tubetto miscela, può causare un surriscaldamento del motore.

Nel caso si lasci consumare tutta la miscela contenuta nel serbatoio, il motore si spegnerà da solo. Il numero di giri del motore aumenta nel funzionamento al minimo mentre il serbatoio si svuota, pertanto le operazioni indicate sopra non servono.



Applicare dall'apertura del carburatore un olio "after run" e dare dei colpetti con lo strappo, in maniera da metterlo in circolo. Questo passo è necessario se non utilizzate la macchina per più di un giorno, in quanto il metanolo evaporando lascia dei residui di acqua che sono dannosi per il motore. E' consigliabile controllare sempre che tutte le viti ed i dadi siano ben stretti ed ove necessario applicare del frena filetti.

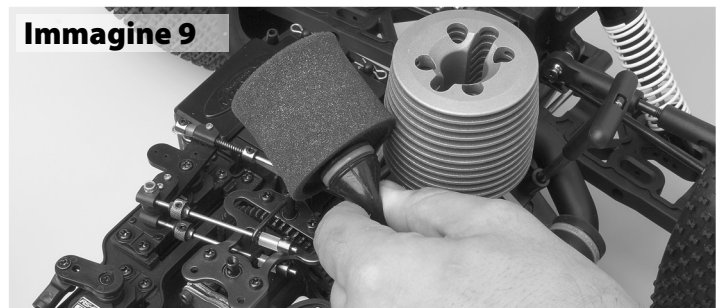

Mantenere la macchina pulita aiuta anche a lavorarci intorno. Per pulire si può utilizzare un compressore ad aria, o appositi prodotti spray o a pennello. Controllare sempre le batterie del trasmettitore e della ricevente prima di mettere in funzione il motore.

Consiglio:

Indossare appositi guanti quando il motore è caldo!

j. *Trattamento dei problemi*

Leggere queste avvertenze prima che si verifichino!

Il motore non parte

Motore ingolfato. Troppa miscela nel motore	Smontare la candela, tirare lo strappo 6 - 8 volte, attenzione agli spruzzi di miscela.
Candela bruciata	Smontare la candela, collegarla alla pipetta candela. Se rimane nera vuol dire che è bruciata, se diventa arancio è ancora buona.
Alimentatore candela scarico	Montate una candela nuova. Se non si accende, cambiate la pipetta candela o sostituite la batteria.

Serbatoio vuoto/ non arriva miscela al motore	Riempite il serbatoio. Tappare con un dito lo scarico e fare l'avviamento con lo strappo.
Surriscaldamento	Se il motore è molto caldo si può bloccare, quindi lasciare raffreddare per 5/10 minuti.

Calo di prestazioni del motore

Surriscaldamento	Controllare la temperatura. Se supera 150 gradi, ingrassare la carburazione. Assicuratevi che le ruote girino senza impedimenti.
Tubetto presa di pressione staccato	Ricollegare la presa di pressione della marmitta al serbatoio.

Filtro aria sporco	Lavarlo con acqua e sapone, quindi imbevvelo con l'apposito olio per filtri (N° 50 003 2648).
Carburatore lento	Controllare il dado bloccaggio carburatore. Spingere il carburatore nell'apposita sede e stringere bene il dado per evitare bolle d'aria.

Difficoltà di controllo, Interferenze

Batterie scariche o danneggiate	Le batterie del trasmettitore debbono essere completamente cariche. Se i servi si muovono lentamente si stanno scaricando le batterie della ricevente.
Regolazioni trasmettitore sbagliate	Controllare le istruzioni di regolazione del radiocomando.
Il modello non si muove	Il trasmettitore o l'interruttore del modello non è acceso. Errata polarità o batteria sbagliata. Le batterie sono esaurite.

Non va dritto	Il trim dello sterzo non è regolato bene. I dadi bloccaggio ruote anteriori e posteriori sono troppo serrati.
Non frena	Il trim del freno non è regolato bene.
Va piano	Il motore ha perso potenza. I dadi bloccaggio ruote posteriori sono troppo stretti. C'è sporco o corpi estranei negli ingranaggi.



50 000 2158 2x

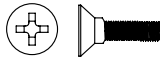

50 020 5431 4x



50 020 5463 2x



50 020 5437 2x

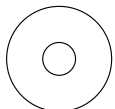

50 020 5437 2x

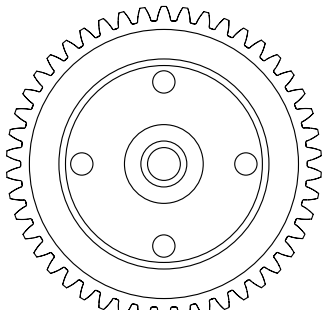

50 020 5464 1x

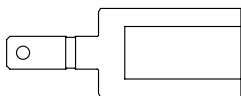

50 020 5463 2x



50 020 5467 1x



50 020 5437 2x

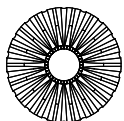

50 020 5437 2x



50 020 5437 2x

Montageanleitung • Assembly • Assemblage • Montaje • Montaggio

1

Center Gear Differential • Mitteldifferential • Différentiel central • Coronal Central • Differenziale centrale ad ingranaggi

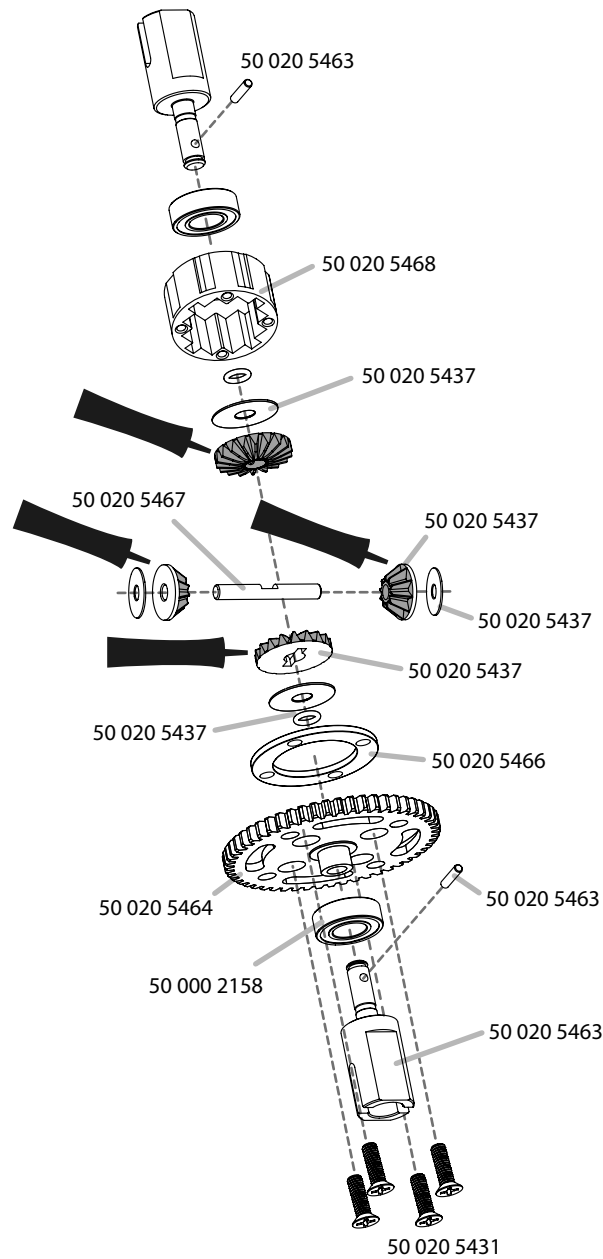

Tuning Tipp

Silicon-Oil
Silikonöl/
Getriebeöl 908052-55



50 090 8052 Silicon Oil 50 ml 1000
50 090 8053 Silicon Oil 50 ml 3000
50 090 8054 Silicon Oil 50 ml 5000
50 090 8055 Silicon Oil 50 ml 7000



Schraubensicherungslack • Liquid screw lock • Frein filet •
Líquido fijatornillos • Frenafiletts



Grease • Fett • Graisse
Grasa • Grease



Silicon Oil • Silikonöl • Huile silicone • Aceite de silicona • Silicon Oil

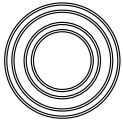

50 000 2158



50 020 5431



50 020 5469



20 50 05437

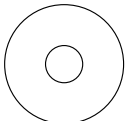

50 020 5437

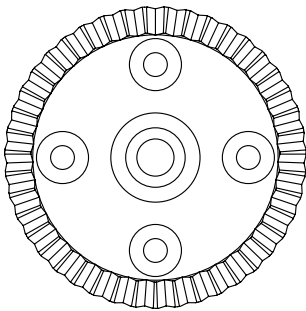

50 020 5465

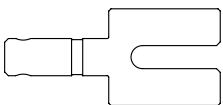

50 020 5469



50 020 5467



50 020 5437

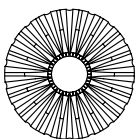

50 020 5437



50 020 5437

2

**Front and Rear Differential • Vorderes und hinteres Differential
• Différentiel avant et arrière • Diferenciales delantero y trasero • Differen-
ziale anteriore e posteriore**

2x

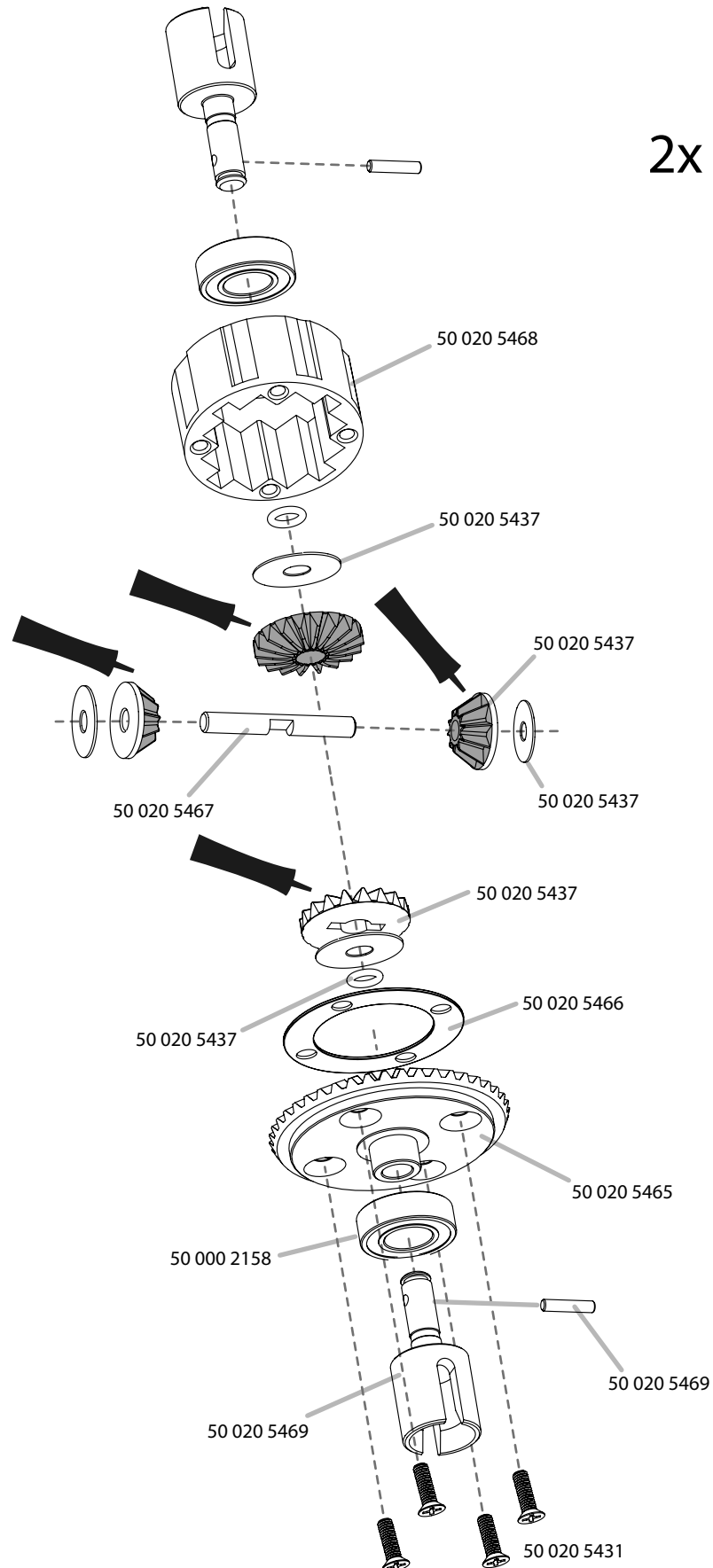

Montage

3

Front Transmission • Vorderes Getriebe • Transmission avant • Transmisión delantera • Trasmissione anteriore



13 x 8 x 0,2 mm 4x



50 000 2158 4x
8 x 16 x 5 mm

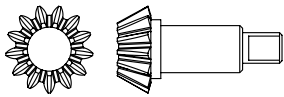

50 020 5457 2x

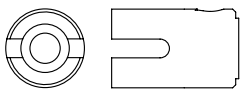

50 020 5459 2x

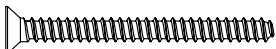

50 020 5432 2x



2x



50 020 5431 4x

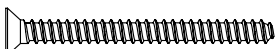

50 020 5431 2x

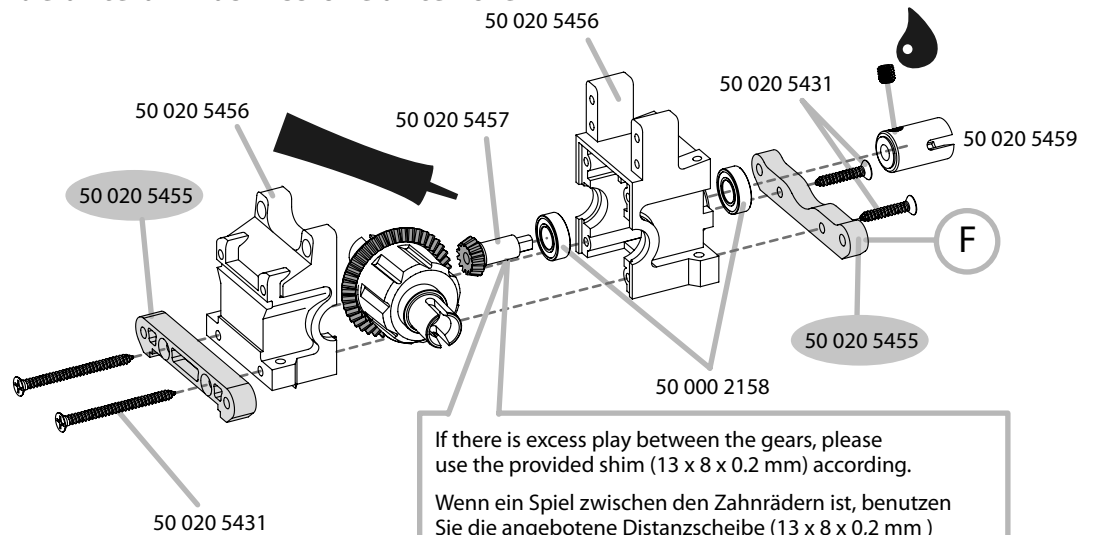

If there is excess play between the gears, please use the provided shim (13 x 8 x 0.2 mm) according.

Wenn ein Spiel zwischen den Zahnrädern ist, benutzen Sie die angebotene Distanzscheibe (13 x 8 x 0,2 mm)

En cas de jeu excessif entre les pignons, utiliser la plaque d'entretoise fournie (13 x 8 x 0,2 mm)

Si existiese un exceso de juego entre los engranajes, por favor utilice las arandelas (13 x 8 x 0,2 mm) suministradas

In caso di eccessivo gioco tra gli ingranaggi, applicare le rondelle (13 x 8 x 0,2 mm) fornite

Rear Transmission • Hinteres Getriebe • Transmission arrière • Transmisión trasera • Trasmissione Posteriore

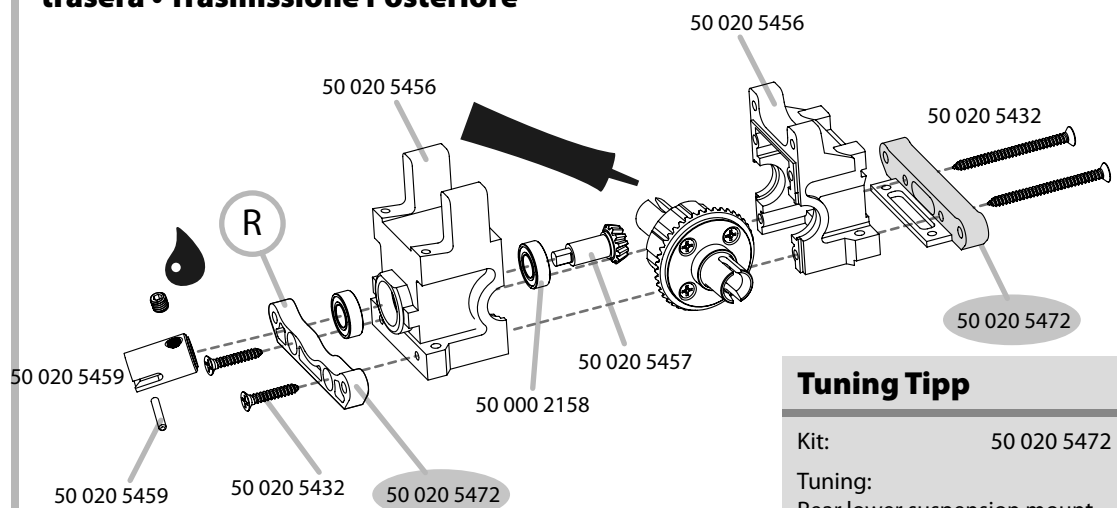

Tuning Tipp

Kit: 50 020 5472

Tuning:
Rear lower suspension mount
(Aluminium)
untere Querlenker
hinten (Alu) 50 020 5507 3°
50 020 5508 2°



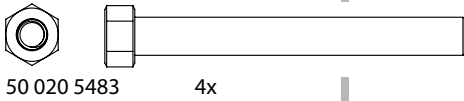
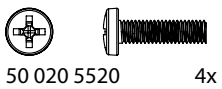
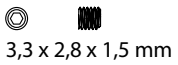
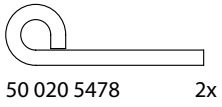
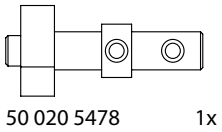
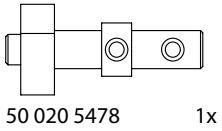
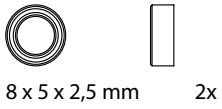

4

Center Differential • Mitteldifferenzial • Différentiel central • Diferencial central • Differenziale centrale

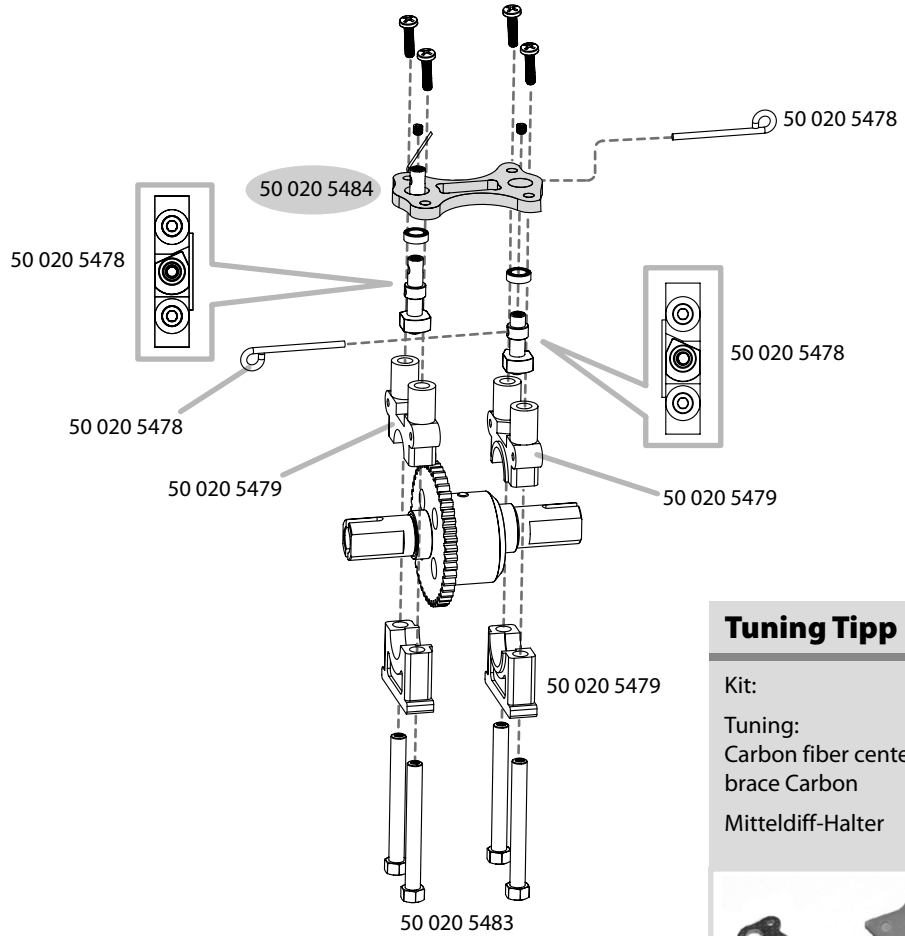



Tuning Tipp

Kit:	50 020 5484
Tuning:	Carbon fiber center diff brace Carbon
Mitteldiff-Halter	50 020 5510

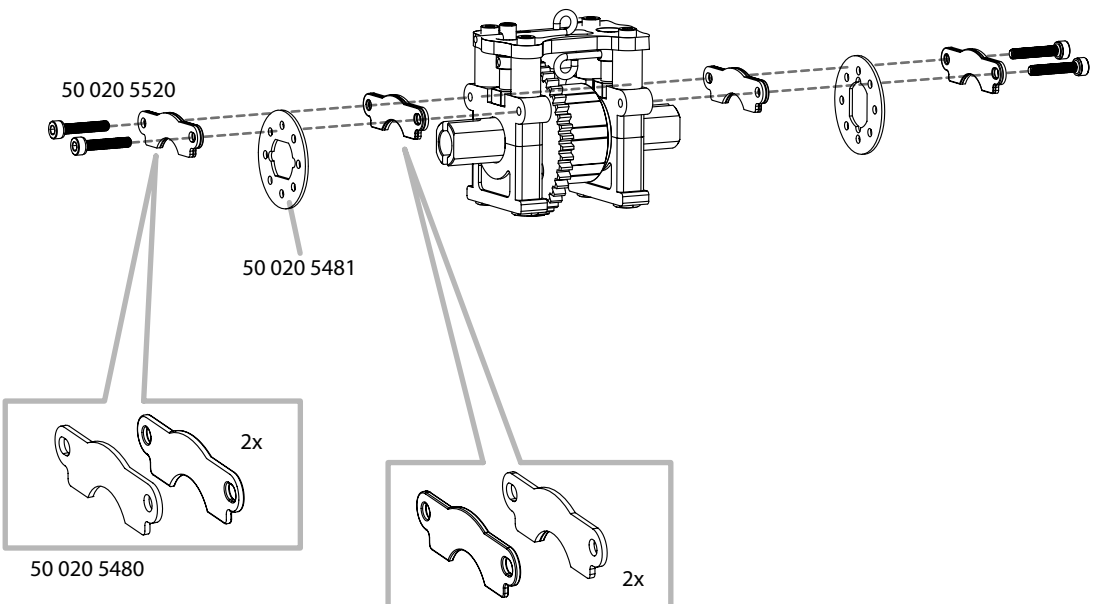
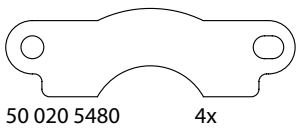
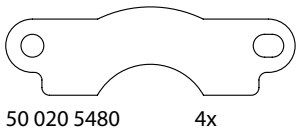
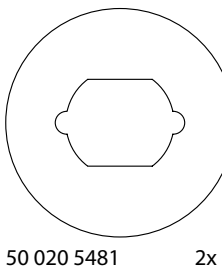
Montage

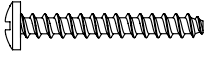

 
50 020 5432 6x

 
50 020 5432 2x

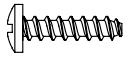
 
50 020 5432 4x

5

Rear Absorber Bridge • Hintere Dämpferbrücke • Support d'amortisseur arrière • Soporte de amortiguadores trasero • Attacco ammortizzatore posteriore

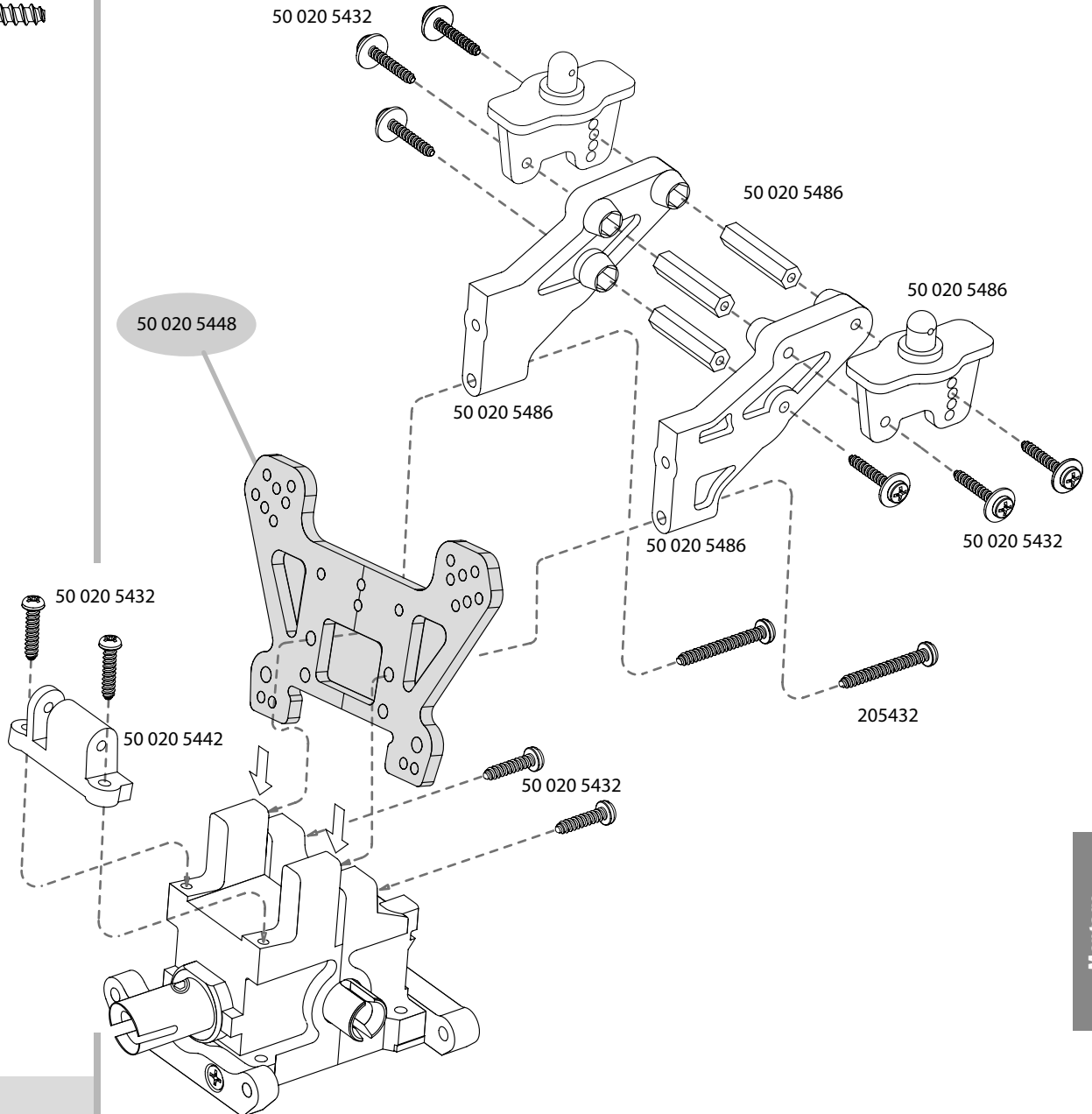

Tuning Tipp

Kit: 50 020 5448

Tuning:
Carbon fiber rear shock tower

Carbon Dämpferbrücke hinten 50 020 5504

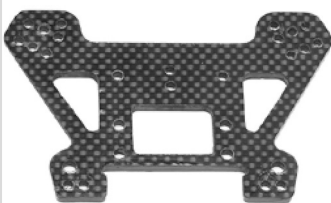



50 020 5432 3x



50 020 5432 1x



12 x 3,9 x 2 mm 2x



50 000 2158 4x



50 020 5431 4x



50 020 5432 1x



50 020 5431 4x

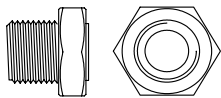

50 020 5439 4x

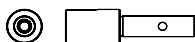

50 020 5445 2x

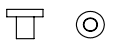

50 020 5707 4x

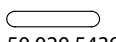

50 020 5439 4x



50 020 5439 4x



M3 1x



50 020 5432 2x



50 020 5520 1x



50 020 5431 4x

6

Rear Absorber Bridge • Hintere Dämpferbrücke • Support d'amortisseur arrière • Soporte de amortiguadores trasero • Attacco ammortizzatore posteriore

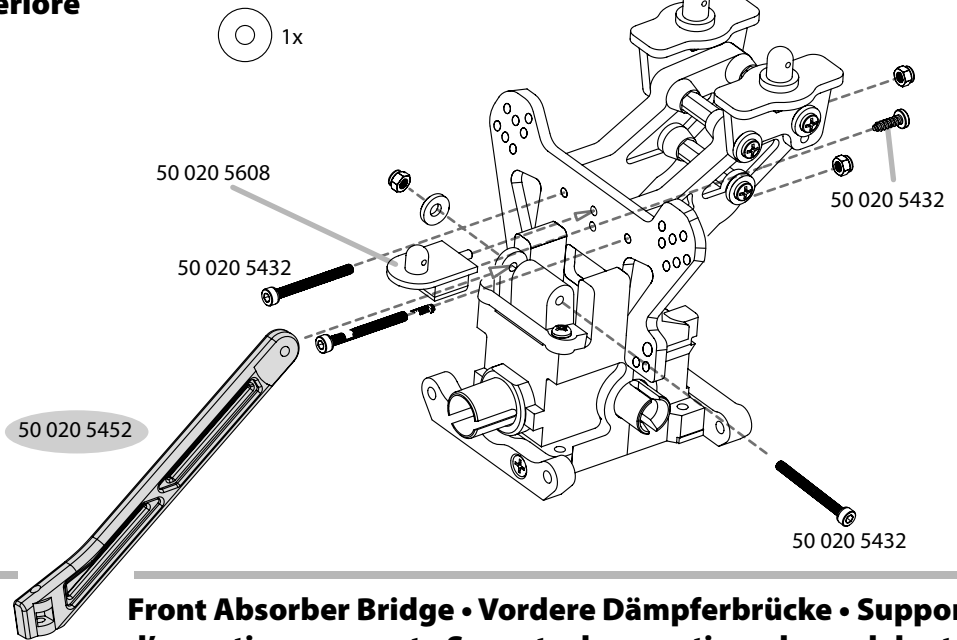

Front Absorber Bridge • Vordere Dämpferbrücke • Support d'amortisseur avant • Soporte de amortiguadores delantero • Attacco ammortizzatore anteriore

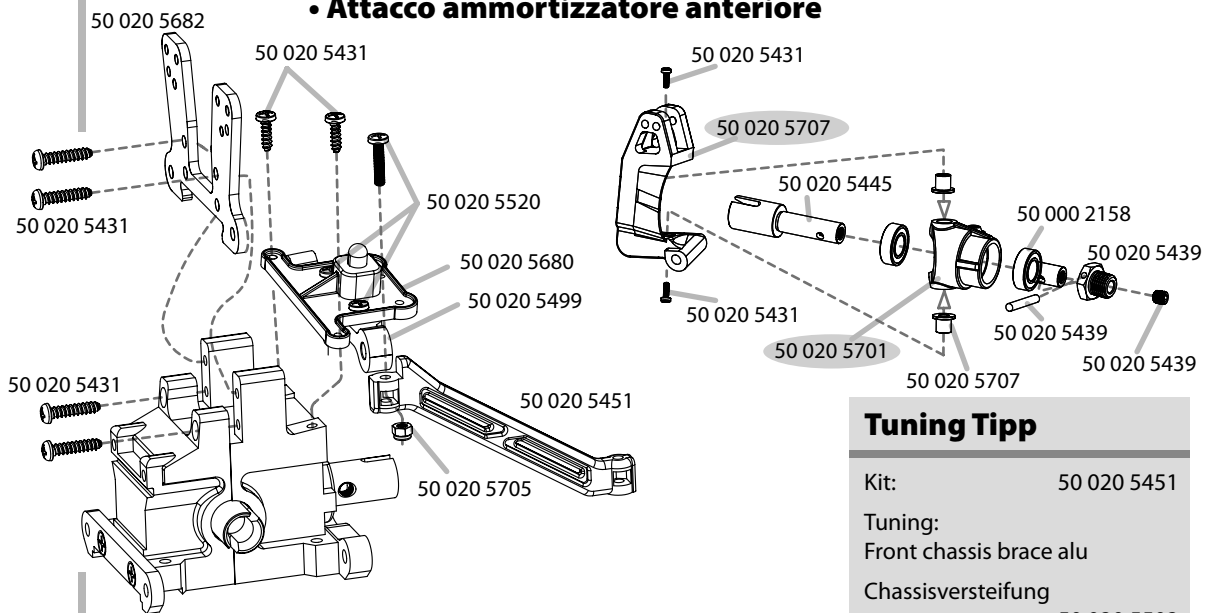

Tuning Tipp

Kit: 50 020 5447

Tuning:
Carbon fiber front
shock tower

Carbon Dämpferbrücke
vorne 50 020 5505



Tuning Tipp

Kit: 50 020 5450

Tuning:
Carbon fiber front brace

Carbon Chassisversteifung
vorne 50 020 5501



Tuning Tipp

Kit: 50 020 5451

Tuning:
Front chassis brace alu

Chassisversteifung
vorne 50 020 5502

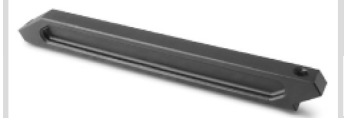

Tuning Tipp

Kit: 50 020 5449

Tuning:
Aluminium upper suspension
mount

obere Querlenkerhalterung
Alu 50 020 5509





2x

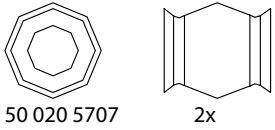

50 020 5707

2x

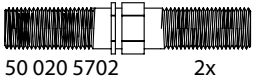

50 020 5702

2x

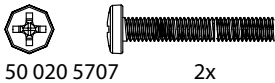

50 020 5707

2x



2x



50 020 5705

2x

7

Front Axle • Vorderachse • Essieu avant • Eje delantero • Assale Anteriore

Assembly of the right and left hand side are the same

Montages côtés droit et gauche identiques

L'assemblaggio del lato destro e sinistro è lo stesso

Zusammenbau rechte und linke Seite identisch

El montaje izquierdo y derecho son iguales

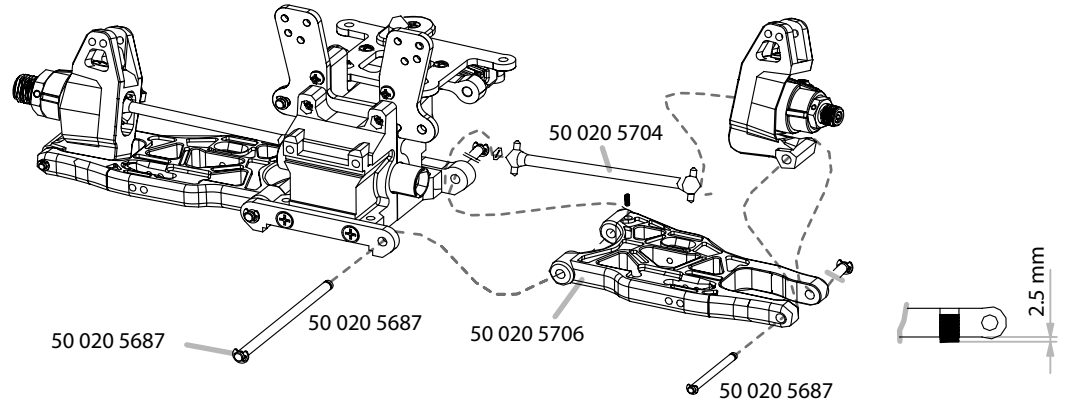

8

Front Suspension • Aufhängung vorne • Suspension avant • Suspensión delantera • Sospensioni Anteriori

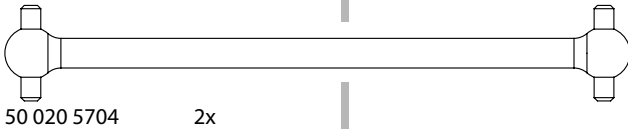

50 020 5704

2x

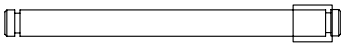

50 020 5687

4x



50 020 5687

20x



50 020 5687

4x

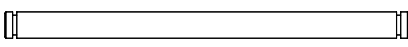

50 020 5687

2x

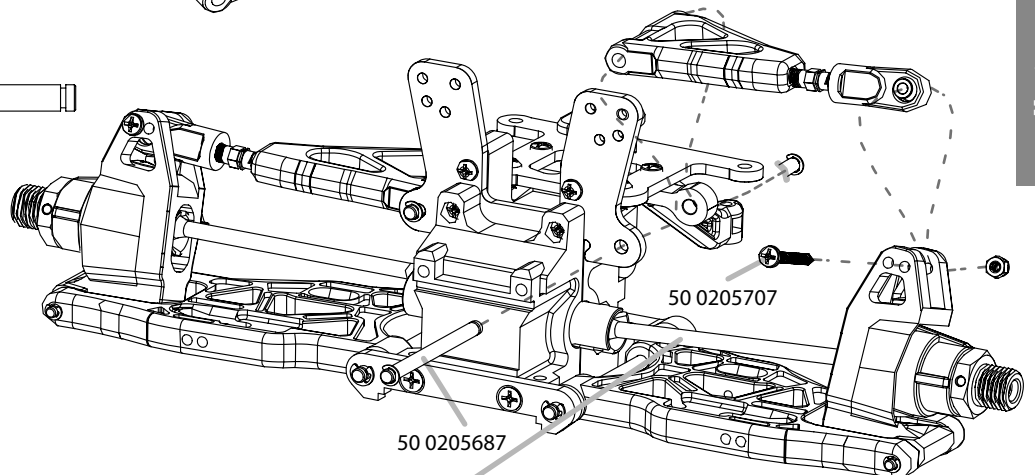
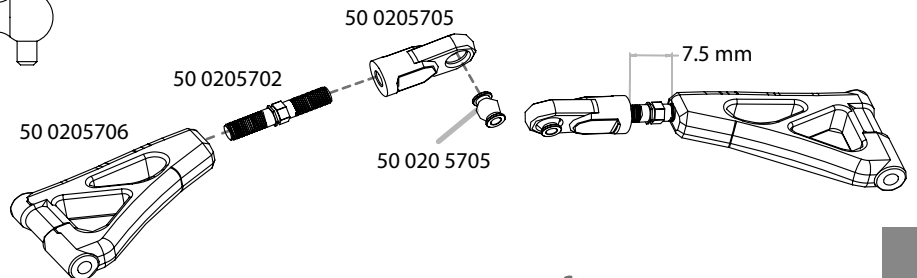

Tuning Tipp

Kit:	50 020 5458
Tuning:	Universal
Antriebswelle	50 020 5514



Insert drive shaft before assembly

Antriebswelle vor dem Zusammenbau einsetzen

Monter l'arbre moteur avant l'assemblage

Inserire el palier antes de montar

Inserire l'albero di trazione prima di montare

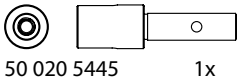

50 020 5445 1x

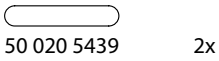

50 020 5439 2x

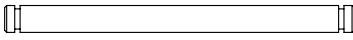

50 020 5443 2x

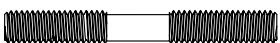

50 020 5444 2x



50 020 5432 2x



50 020 5432 2x



12 x 3.9 x 2 mm 2x

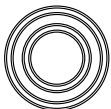

50 000 2158 4x

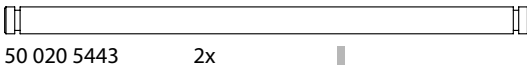

50 020 5443 2x



50 020 5458 2x



50 020 5439 2x

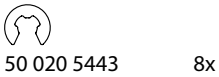

50 020 5443 8x



M3 4x

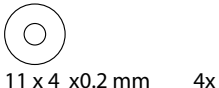

11 x 4 x 0.2 mm 4x

9

Rear Axle • Hinterachse • Essieu arrière • Eje trasero • Assale Posteriore



50 020 5449 2x



50 020 5444 4x

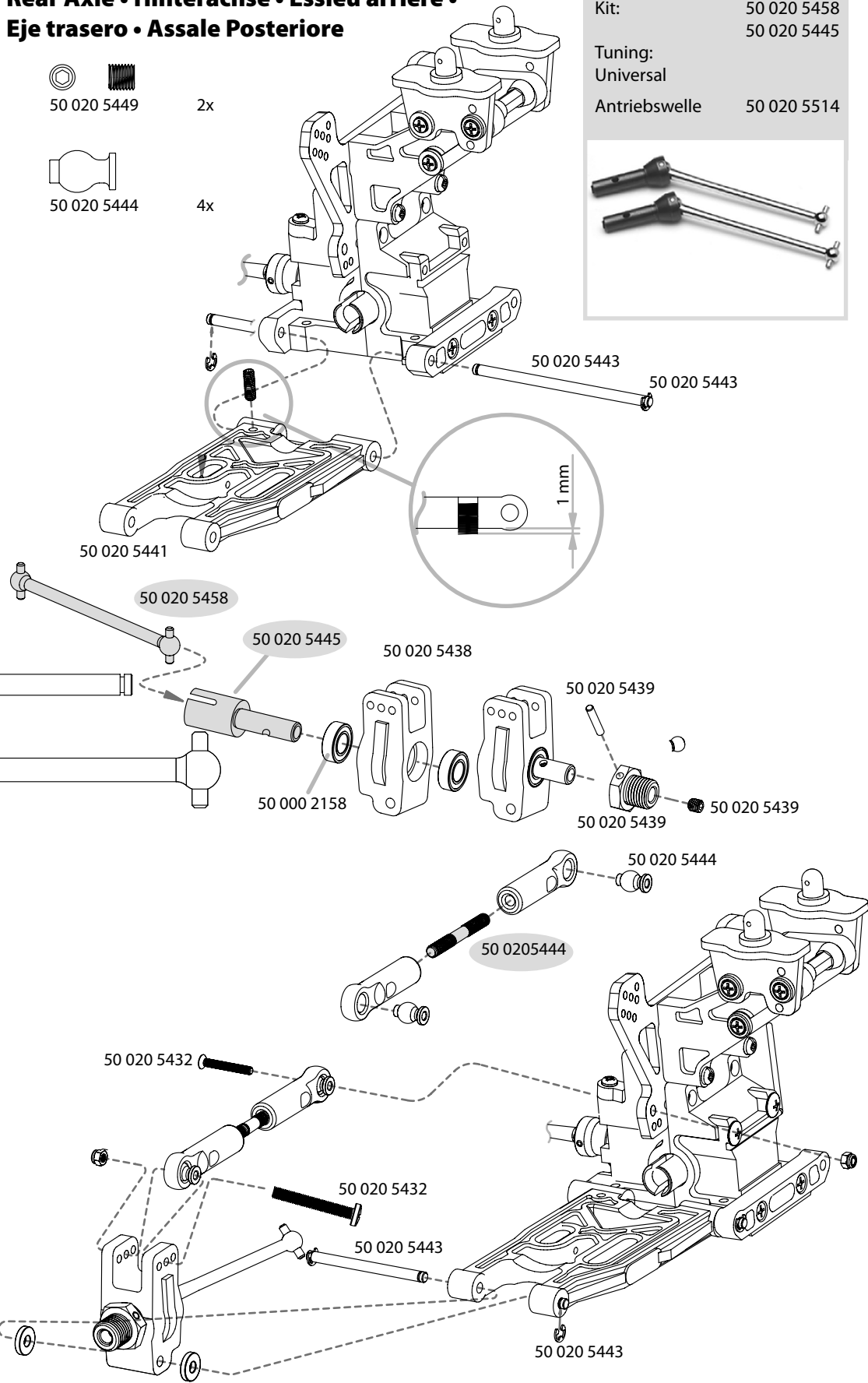

Tuning Tipp

Kit:	50 020 5458 50 020 5445
Tuning: Universal	
Antriebswelle	50 020 5514



Montage

Tuning Tipp

Kit:	50 020 5444
Tuning: Tie rod Alu	
Gewindestange	50 020 5128



 
50 020 5520 1x

 
50 020 5520 4x

 
50 020 5493 1x



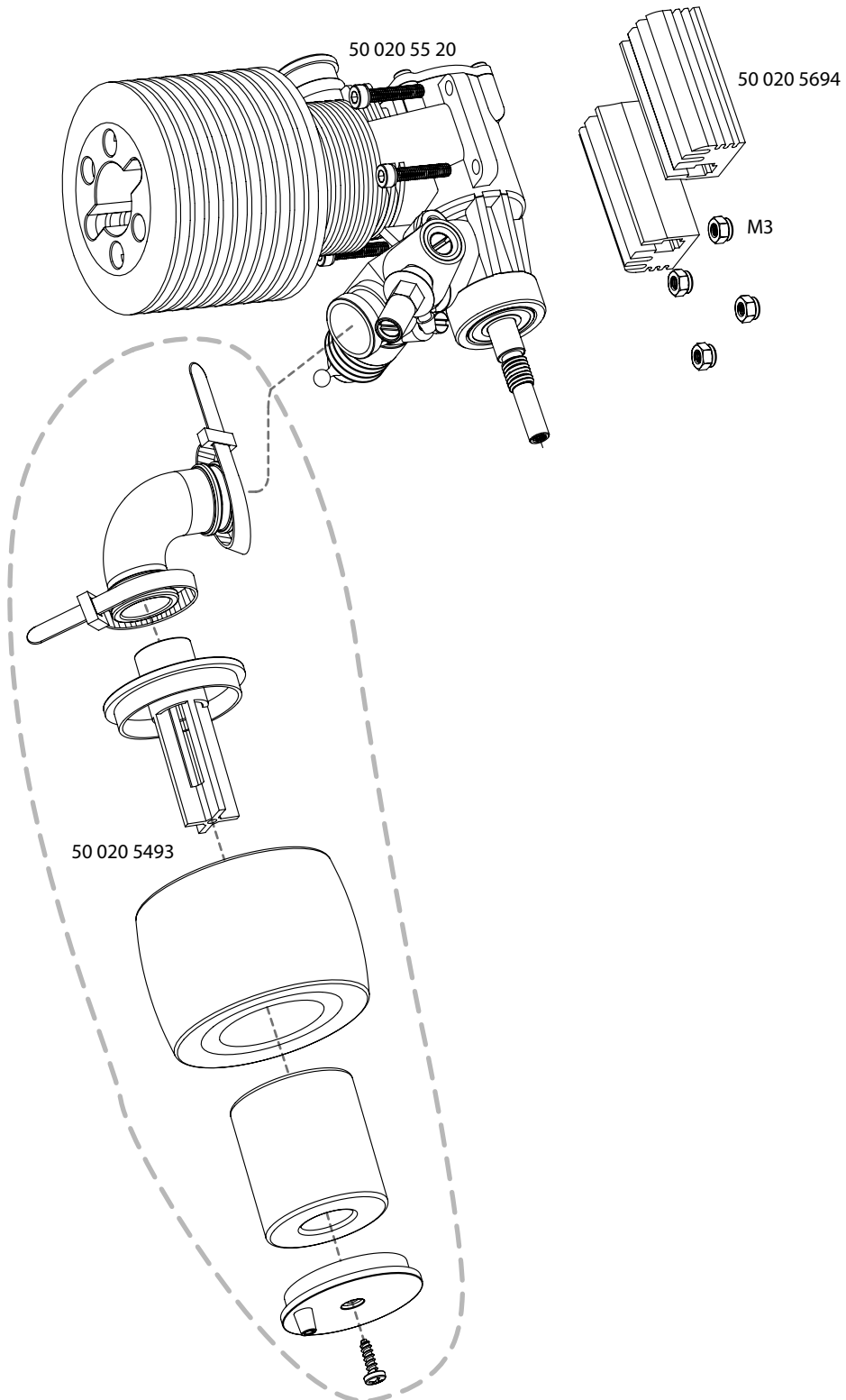





10 Air Cleaner • Luftfilter • Filtre à air • Filtro de aire • Filtro aria

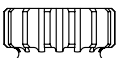

Tuning Tipp

Air Filter Oil
Luftfilteröl 50 003 2648

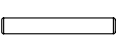
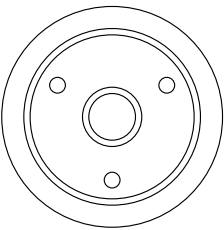

-  1x
-  1x
-  1x
-  50 020 5562 1x
-  50 020 5688 1x
-  50 020 5490 3x
-  50 020 5695 3x
-  50 020 5695 1x
-  50 005 4568 1x

11

Clutch • Kupplung • Embrayage • Embrague • Frizione

0.3 mm

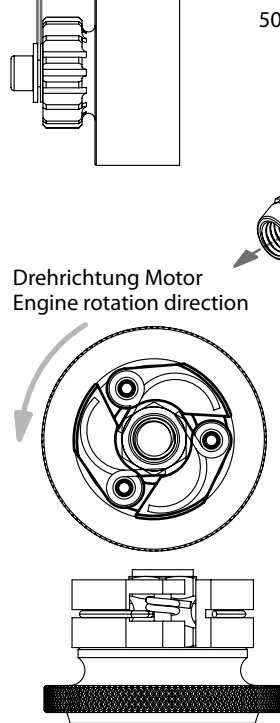

Drehrichtung Motor
Engine rotation direction

50 020 5695

50 020 5688

50 020 5490

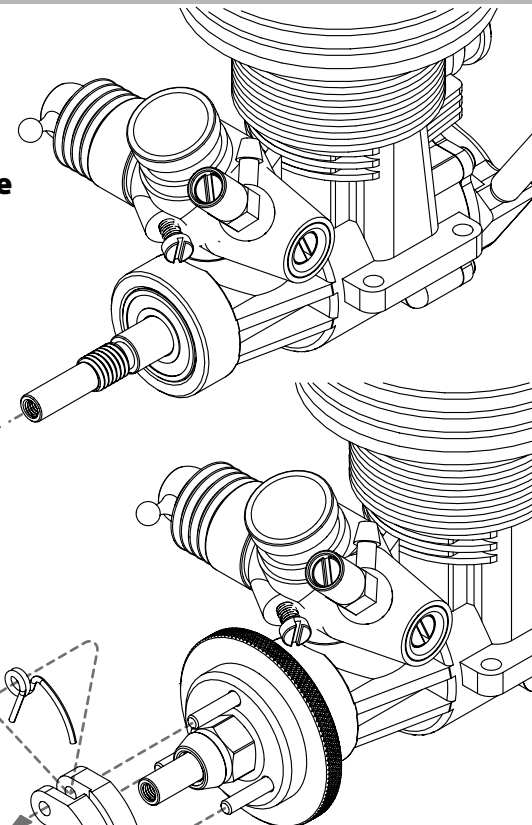

Shim clutch bell if there is about 0.3 mm play between clutch bell and screw.

Das Spiel zwischen Kupplungsglocke und Schraube muss mit Hilfe von „Shim“-Scheiben (dünnen Beilagscheiben) auf ca. 0,3 mm abgestimmt werden.

50 020 5490

Montage

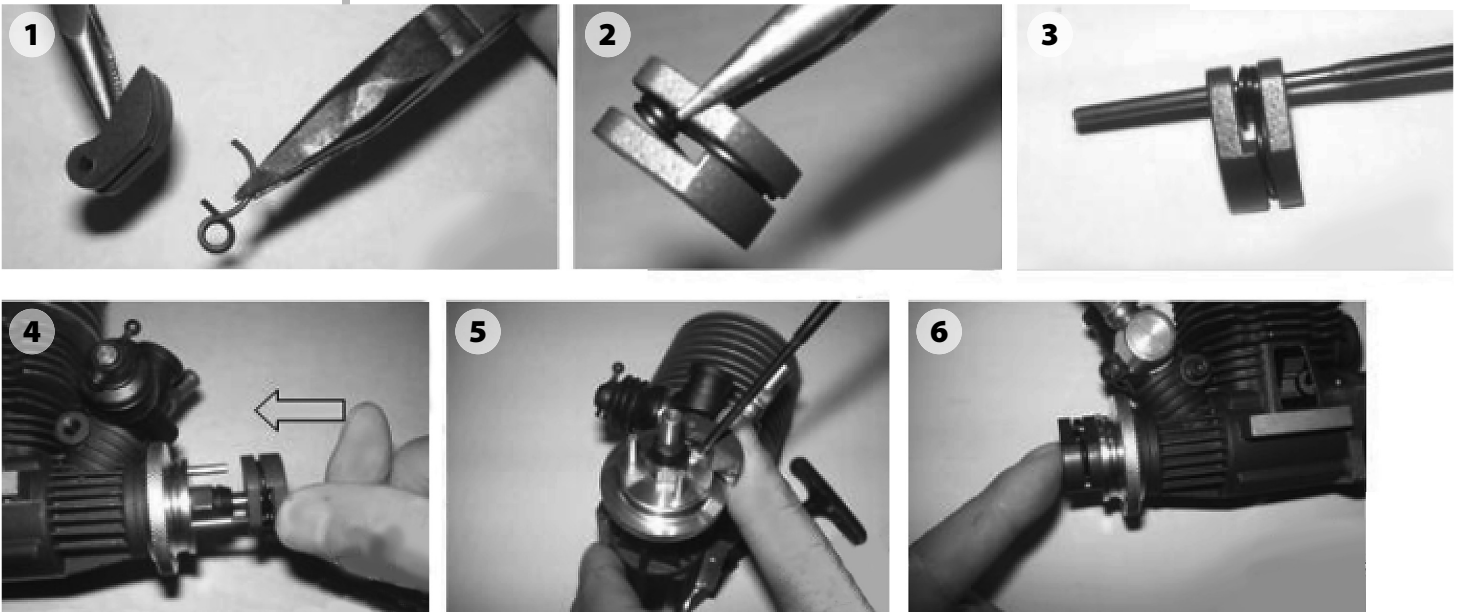

Tuning Tipp

Clutch Bell 15T
Kupplungsglocke 15T 50 020 5562

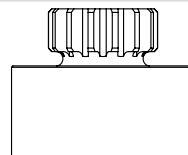

Tuning Tipp

Clutch Bell 13T
Kupplungsglocke 13T 50 020 5492

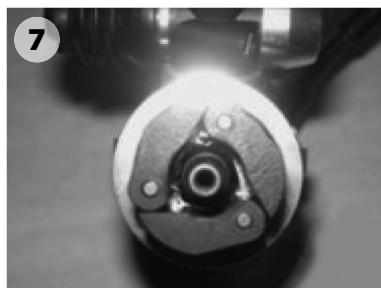
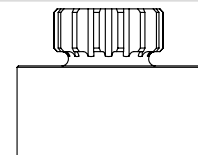

12

Steering • Lenkung • Direction • Dirección • Sterzo

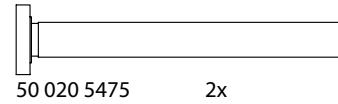

50 020 5475 2x

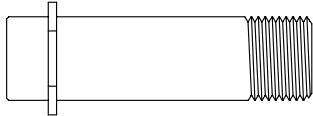

50 020 5691 1x X1



50 020 5520 4x



50 020 5691 1x



50 020 5477 1x



50 020 5691 1x

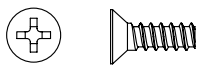

50 020 5433 6x



50 020 5520 2x

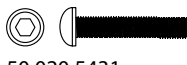

50 020 5431 2x



50 020 5471 4x



50 020 5705 2x

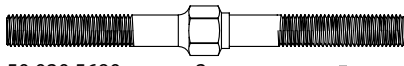

50 020 5690 2x



50 020 5434 2x

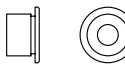

50 020 5434 2x



50 020 5431 4x



50 020 5690 4x



50 000 2146 4x

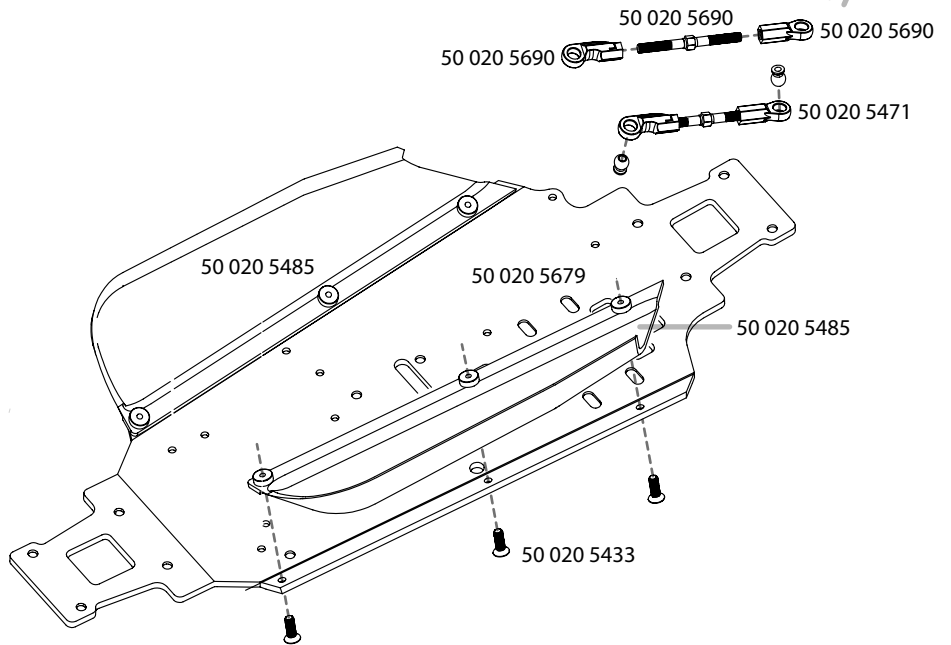
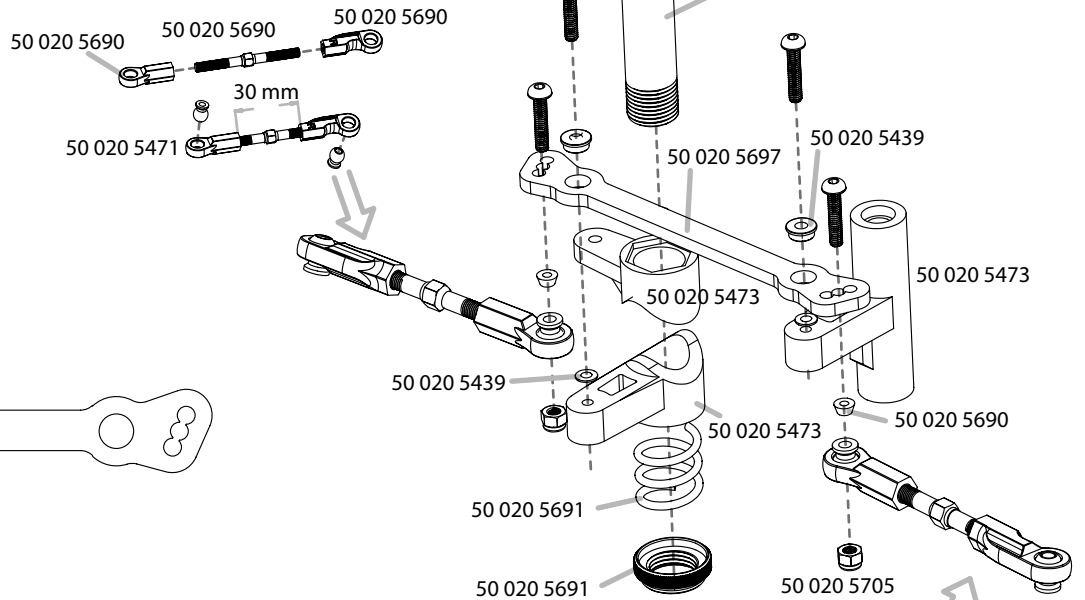

Tuning Tipp

Kit: 50 020 5679
Tuning:
Chassis 50 020 5726

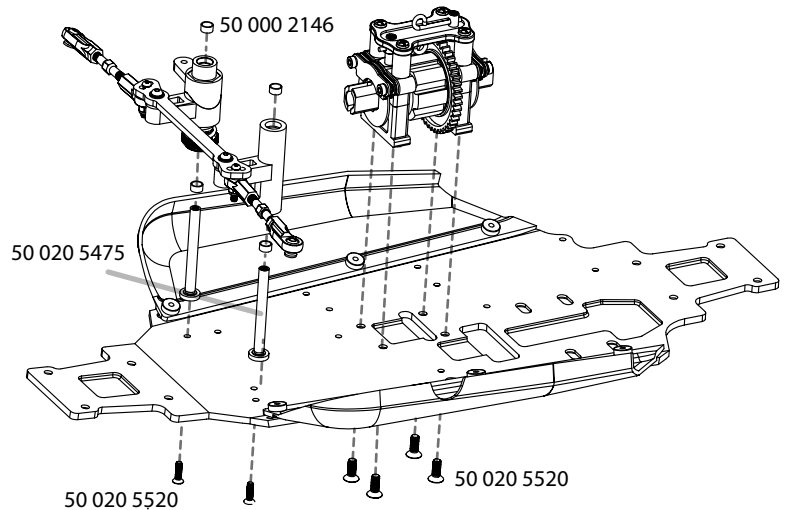

Montage

13

Shocks • Stoßdämpfer • Amortisseur • Amortiguadores • Ammortizzatori

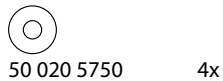
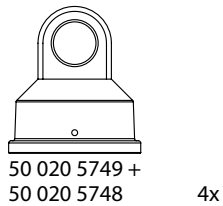
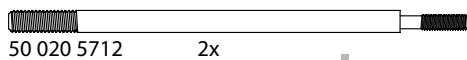
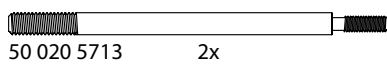
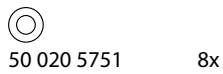
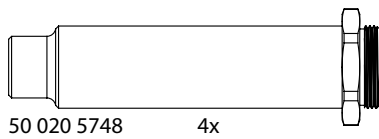
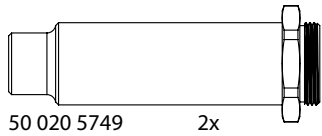

Montage

Tuning Tipp

Kit: Oil
Öl

Tuning: Silicon Oil
Silikonöl



- 50 090 8048 Silicon Oil 50 ml 300
- 50 090 8049 Silicon Oil 50 ml 400
- 50 090 8050 Silicon Oil 50 ml 500
- 50 090 8051 Silicon Oil 50 ml 600

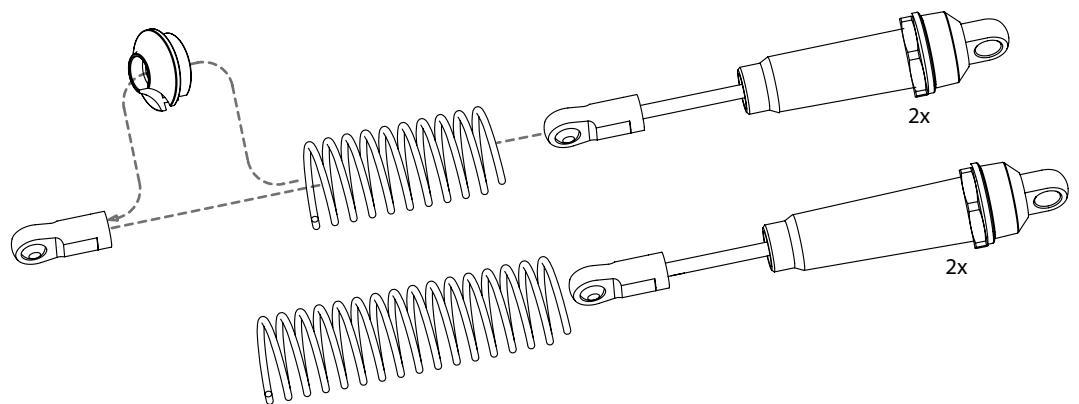
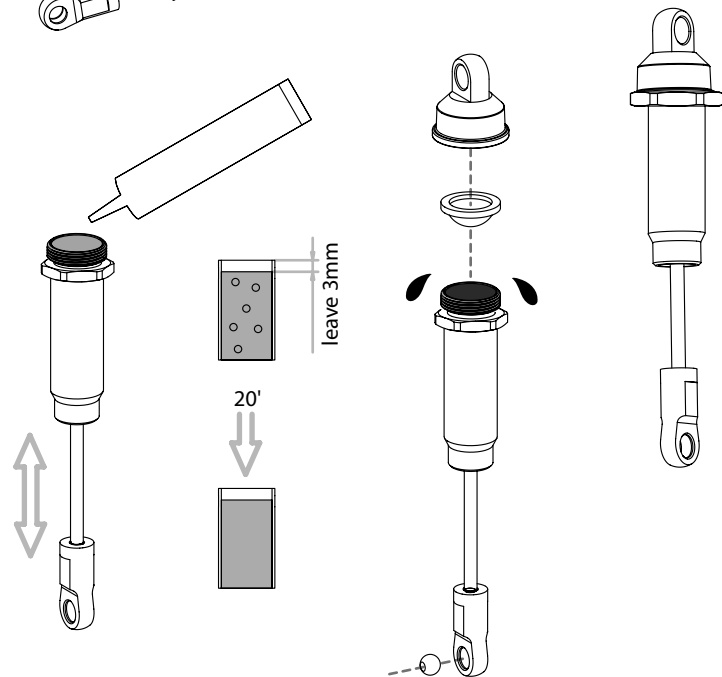
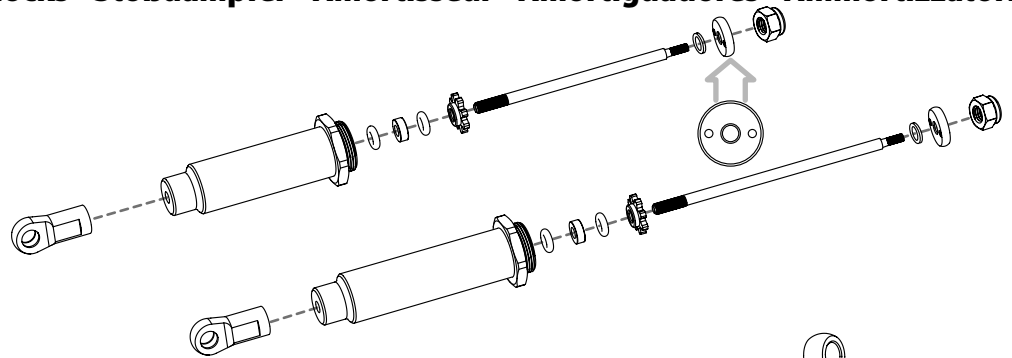

50 020 5471 4x

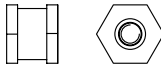
50 020 5497 2x



50 020 5497 4x



50 020 5705 4x

Tuning Tipp

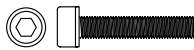
Tuning:
Anti-roll bar front
Stabi vorne 50 020 5733



50 020 5431 4x

50 020 5431 2x

50 020 5432 2x

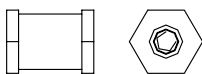
50 020 5686 2x

Tuning Tipp

Tuning:
Anti-roll bar rear
Stabi hinten 50 020 5733



14

**Assembly Shocks • Stoßdämpfer Montage • Montage amortisseur •
Montaje de los amortiguadores • Assemblaggio ammortizzatori**

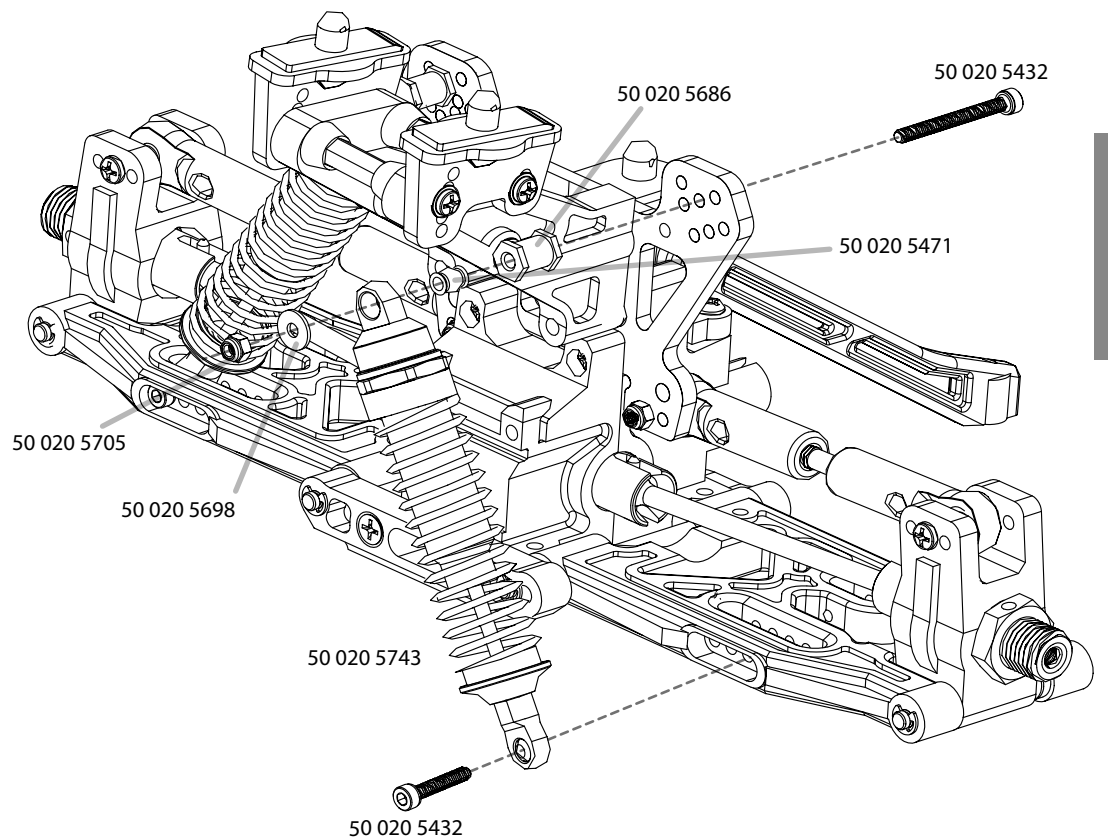
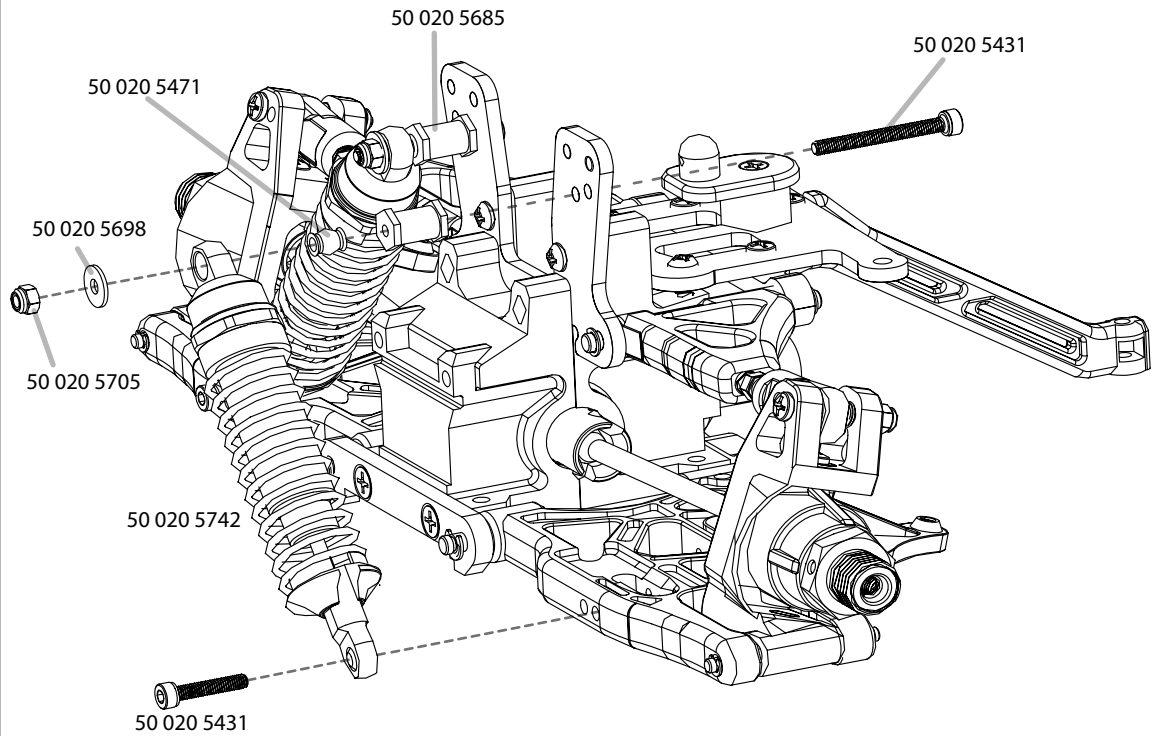

Montage

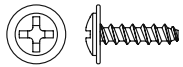

50 020 5433 8x

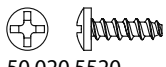

50 020 5520 2x



50 020 5433 4x



50 020 5488 1x

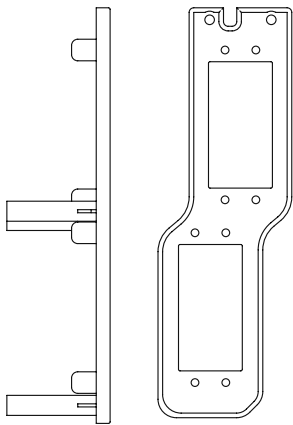

50 020 5488 1x

15

Radio Box • Radioplatte • Support récepteur • Caja de radio • Scatola protezione ricevente

Tuning Tipp

Tuning:
Receiver battery pack
Empfänger-Akku 50 060 8036

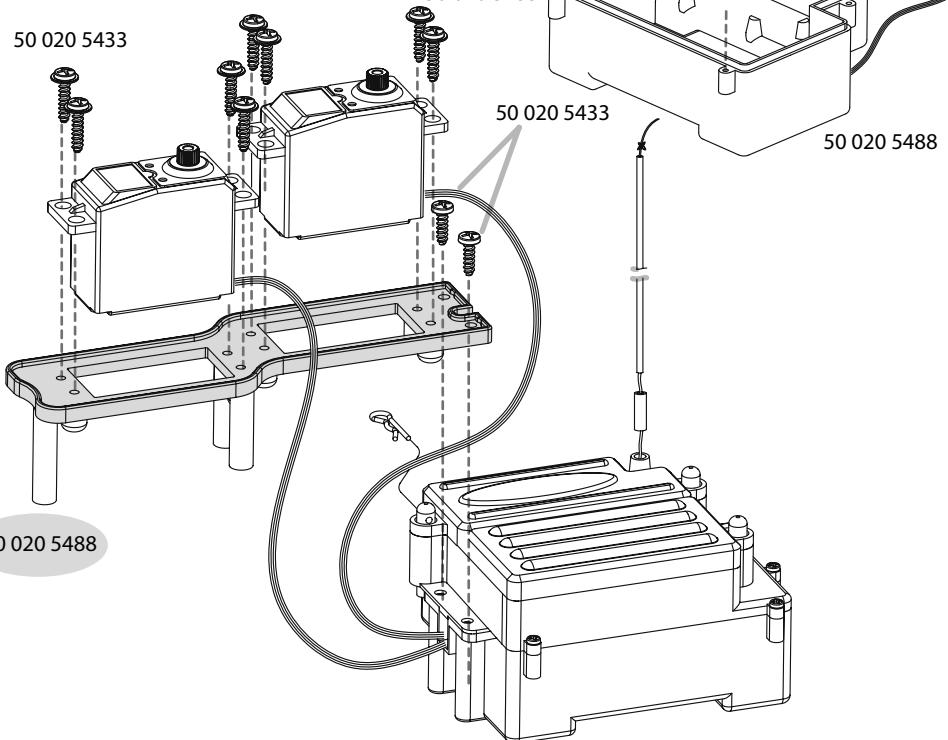
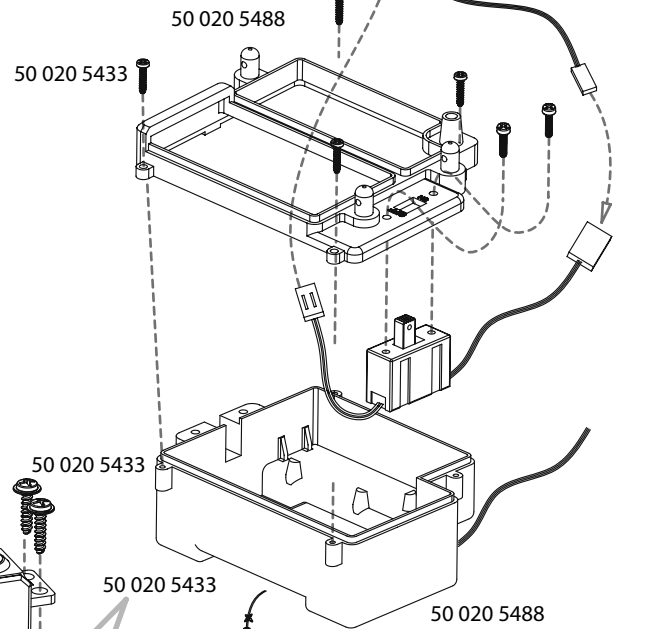
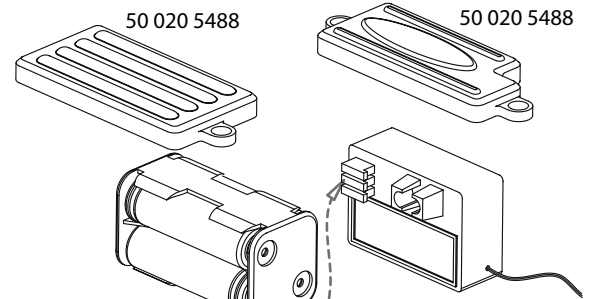

50 020 5488

50 020 5540



Tuning Tipp

Kit: 50 020 5488

Tuning:
Carbon fiber radio plate
Carbon Empfängerhalter 50 020 5511



Tuning Tipp

Kit: 50 020 5540

Tuning:
Carbon fiber radio plate
Carbon Empfängerhalter 50 020 5541

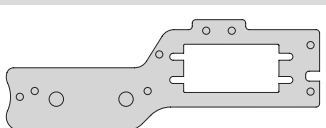

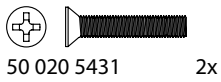
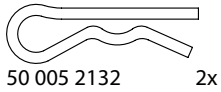
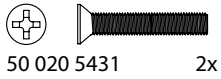
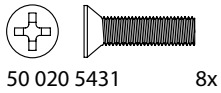

Tuning Tipp

Kit: 50 020 5458
 Tuning:
 Universal
 Antriebswelle 50 020 5515

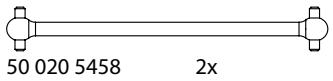

16

Mid Differential + Front Axle + Rear Axle • Mitteldifferenzial + Vorder- + Hinterachse • Différentiel central + essieux avant & arrière • Diferencial central + eje delantero + eje trasero • Differenziale centrale + asse anteriore+ asse posteriore

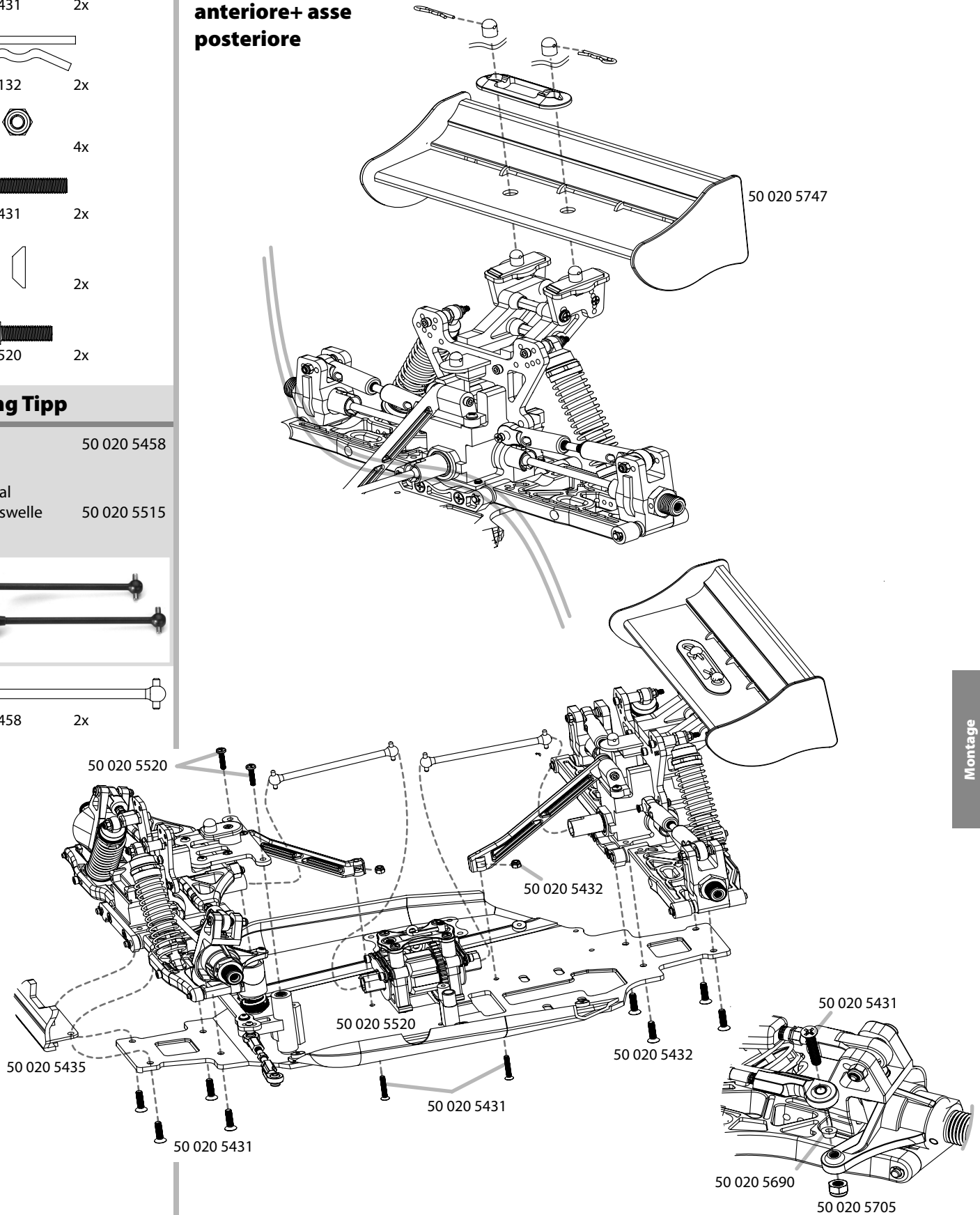

Montage

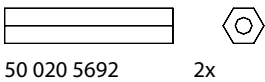
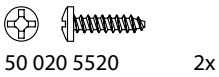
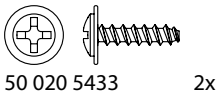
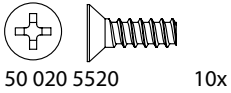

17

Assembly fuel tank • Kraftstofftank • Réservoir de carburant • Depósito de combustible • Serbatoio

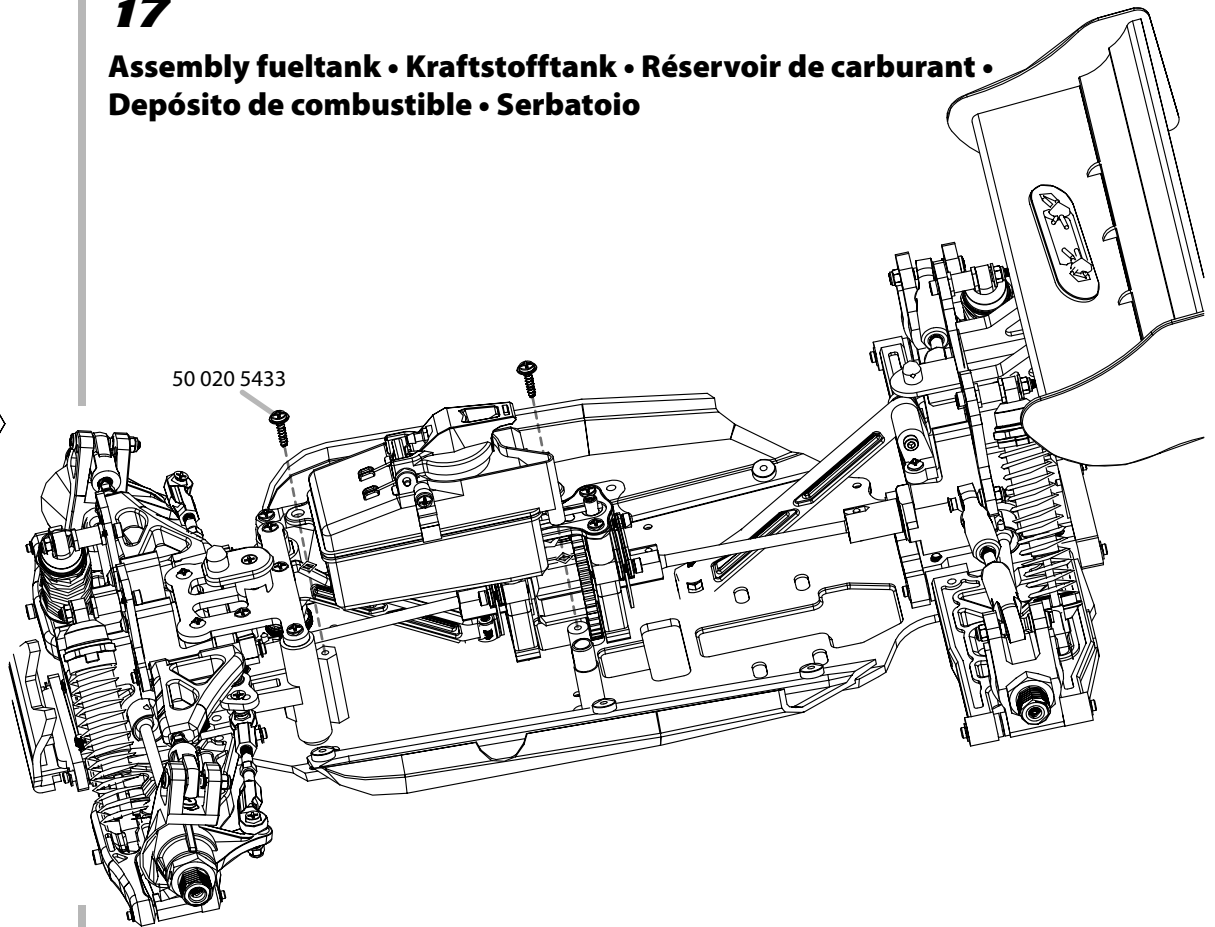

18

Radio Box • Radioplatte • Support récepteur • Caja de radio • Scatola protezione ricevente

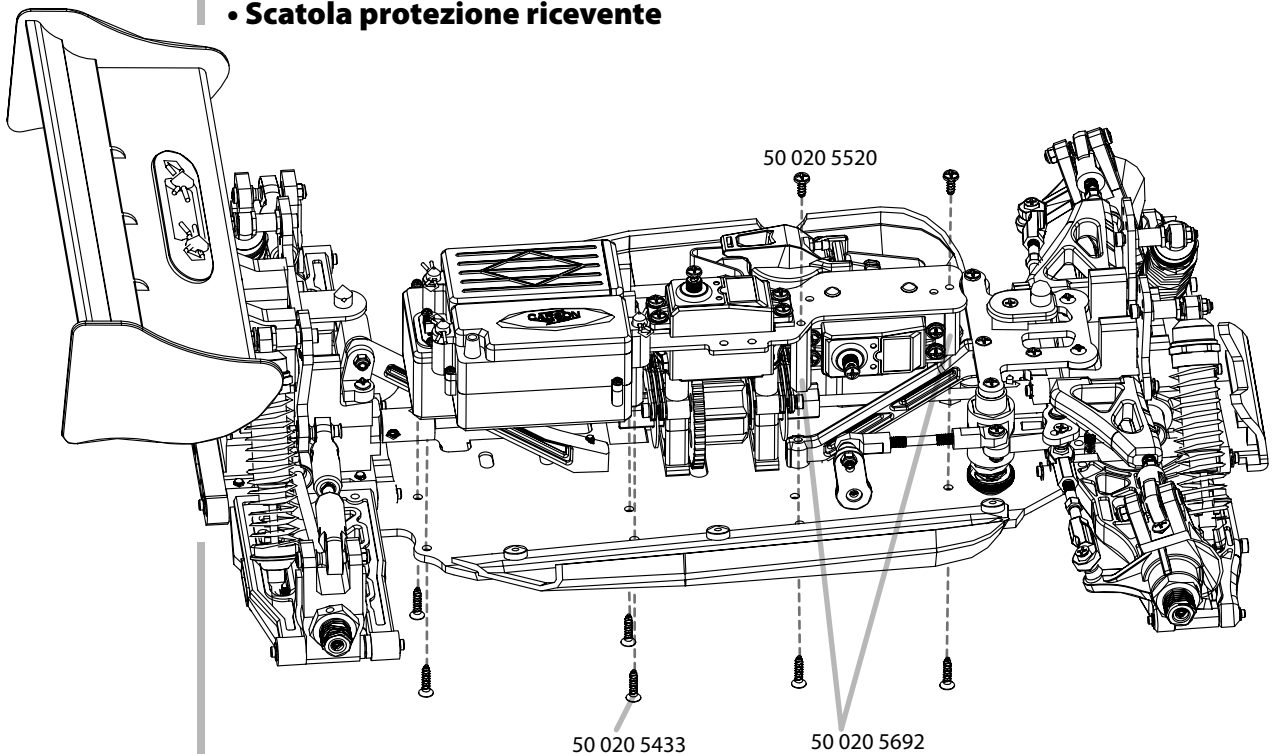

19

Exhaust • Auspuffanlage • Pot d'échappement • Escape • Scarico

50 020 5496 1x

50 020 5496 1x

50 020 5496 1x_{X1}

50 020 5453 1x

50 020 5494 1x

50 020 5494 1x

50 020 5498 4x

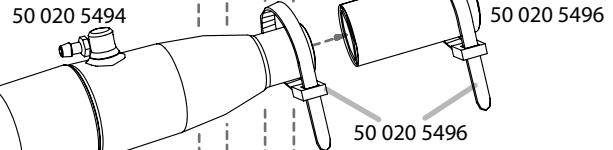
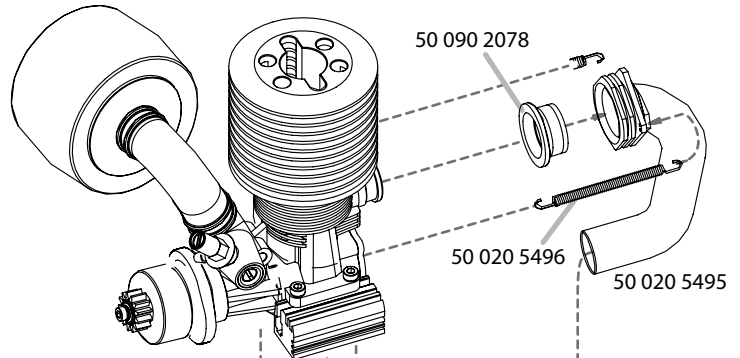

50 020 5496

50 020 5496

50 020 5496

50 020 5496

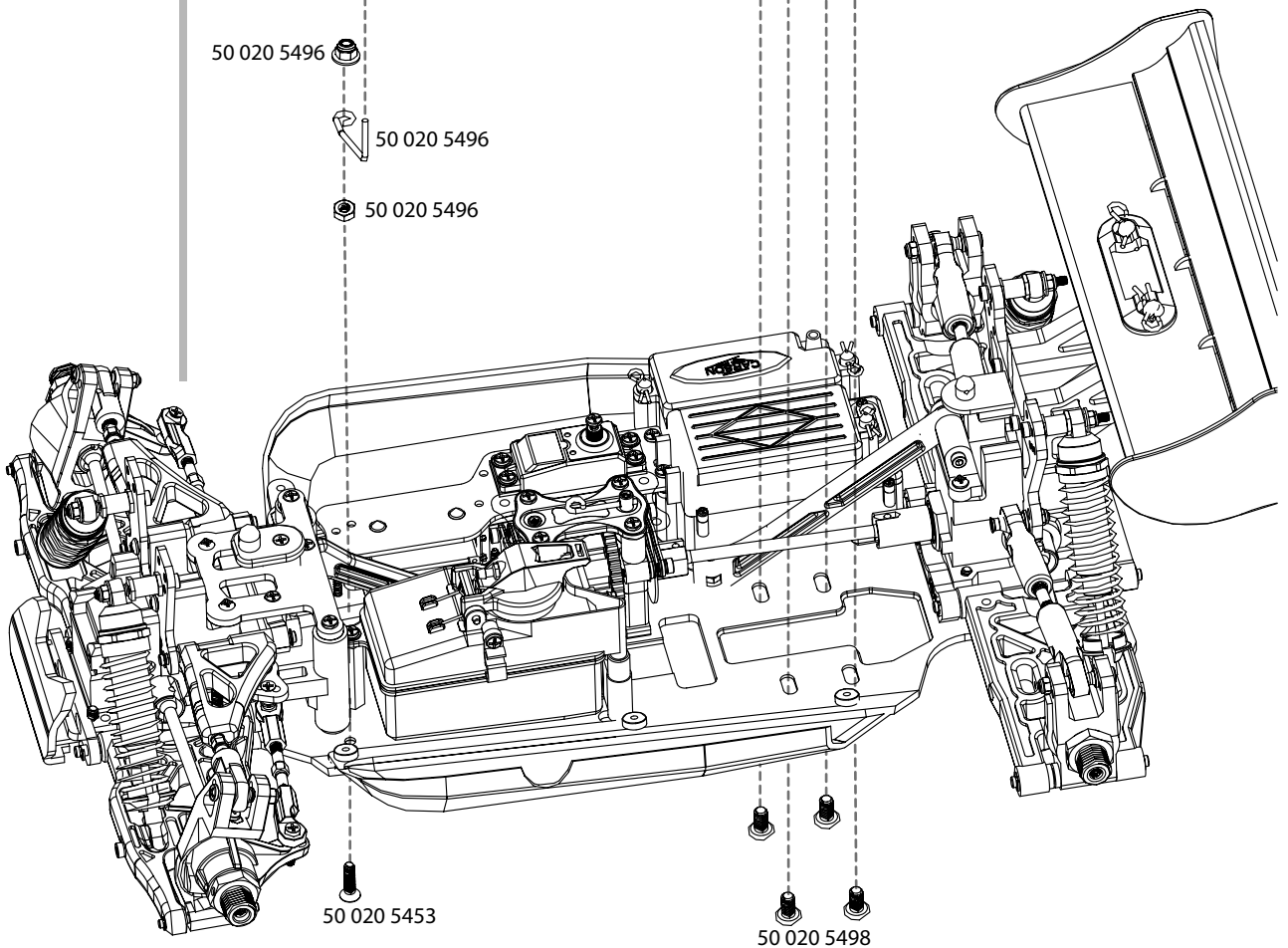

50 020 5453

50 020 5498

Montage

□ ○
50 020 5496 1x

◎ ■
50 020 5496 1x

20

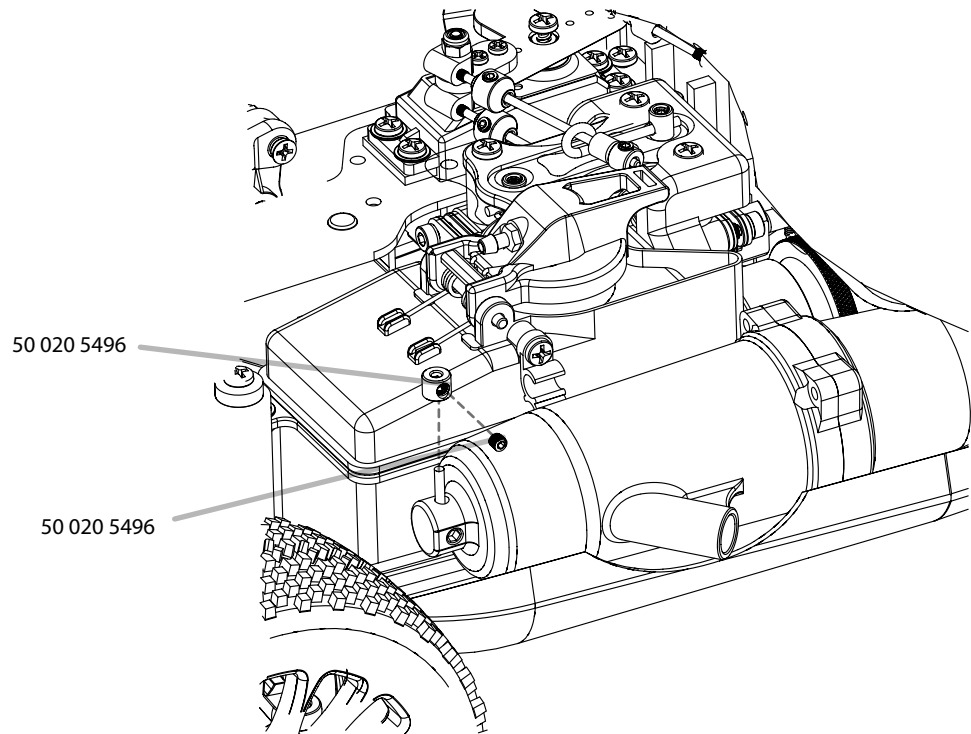

**Montage Spritschlauch • Assembly fueltube • Assemblage boyau d'essence
• Montaje manga gasolina • Montaggio tubo benzina**

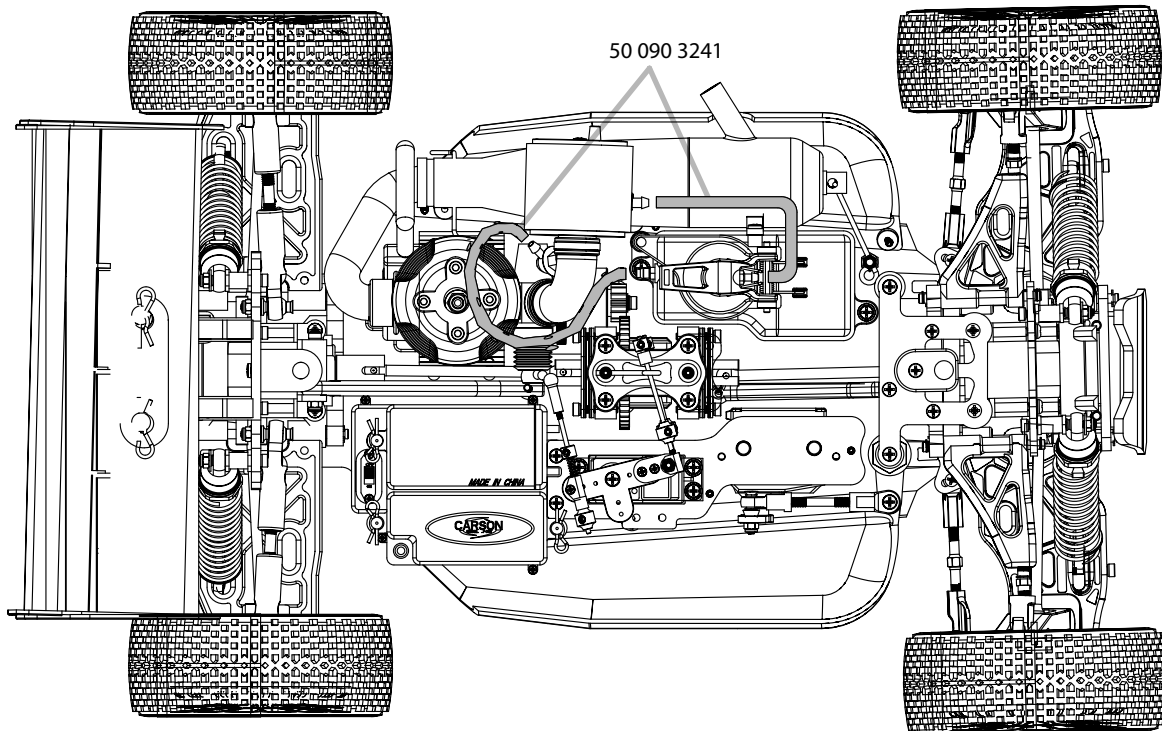



50 020 5461 3x



50 020 5461 3x



50 020 5461 6x

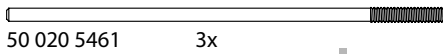

50 020 5461 3x



1x



50 020 5433 1x



50 020 5433 1x

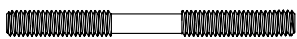

50 020 5476 1x



50 020 5553 1x



50 020 5471 2x



M3 2x

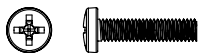

50 020 5431 1x



1x

21

Throttle + brake linkage • Gas- + Bremsgestänge • Barre des gaz et de freinage • Varillaje de acelerador / freno • Collegamenti freno e acceleratore

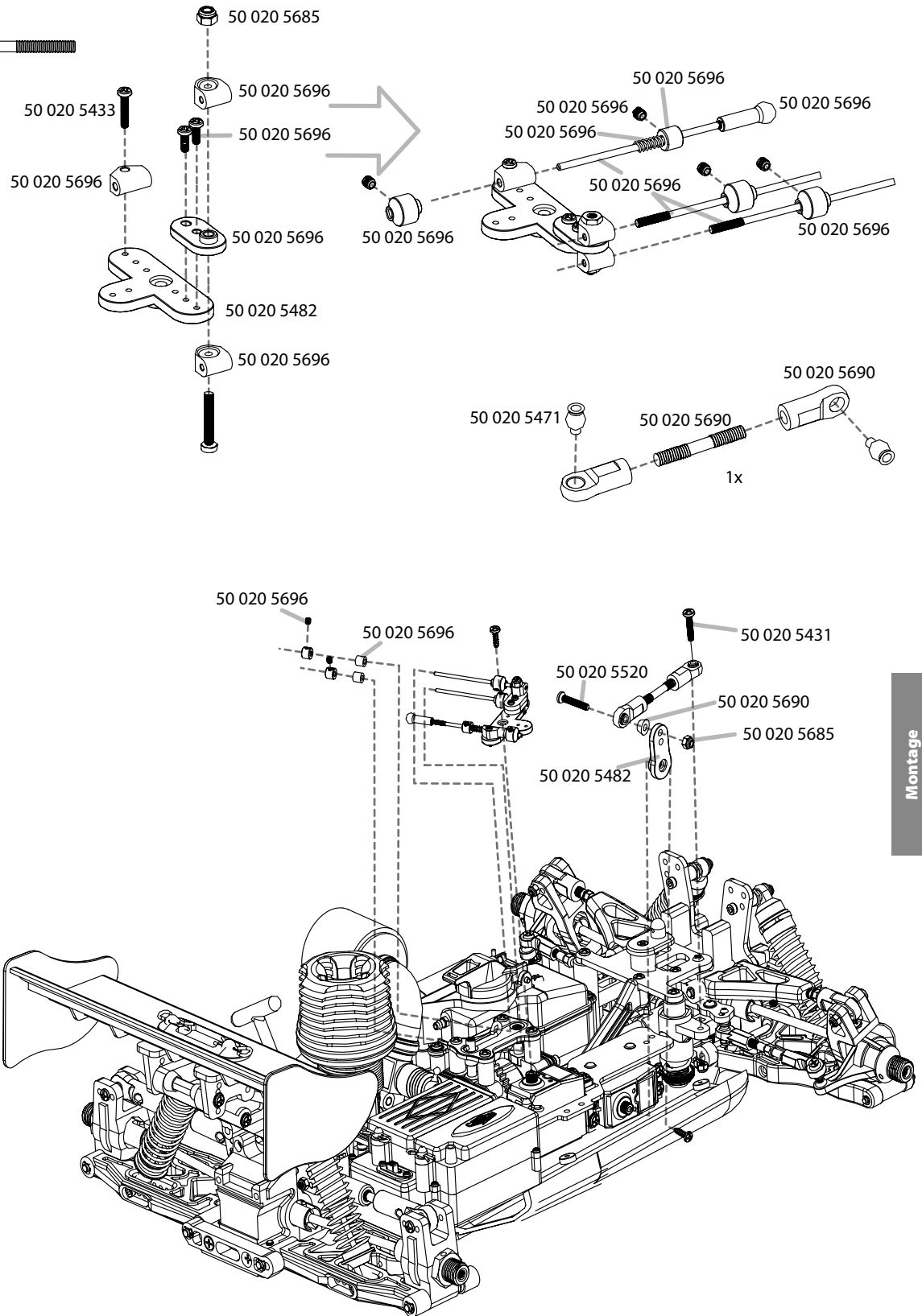

Montage

Tuning Tipp

Kit: 50 020 5476

Tuning:

Tie rods

Alu

Gewindestangen 50 020 5128



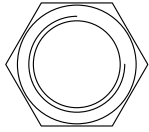

50 020 5689

4x

22

Wheels • Räder • Roues • Ruedas • Ruote

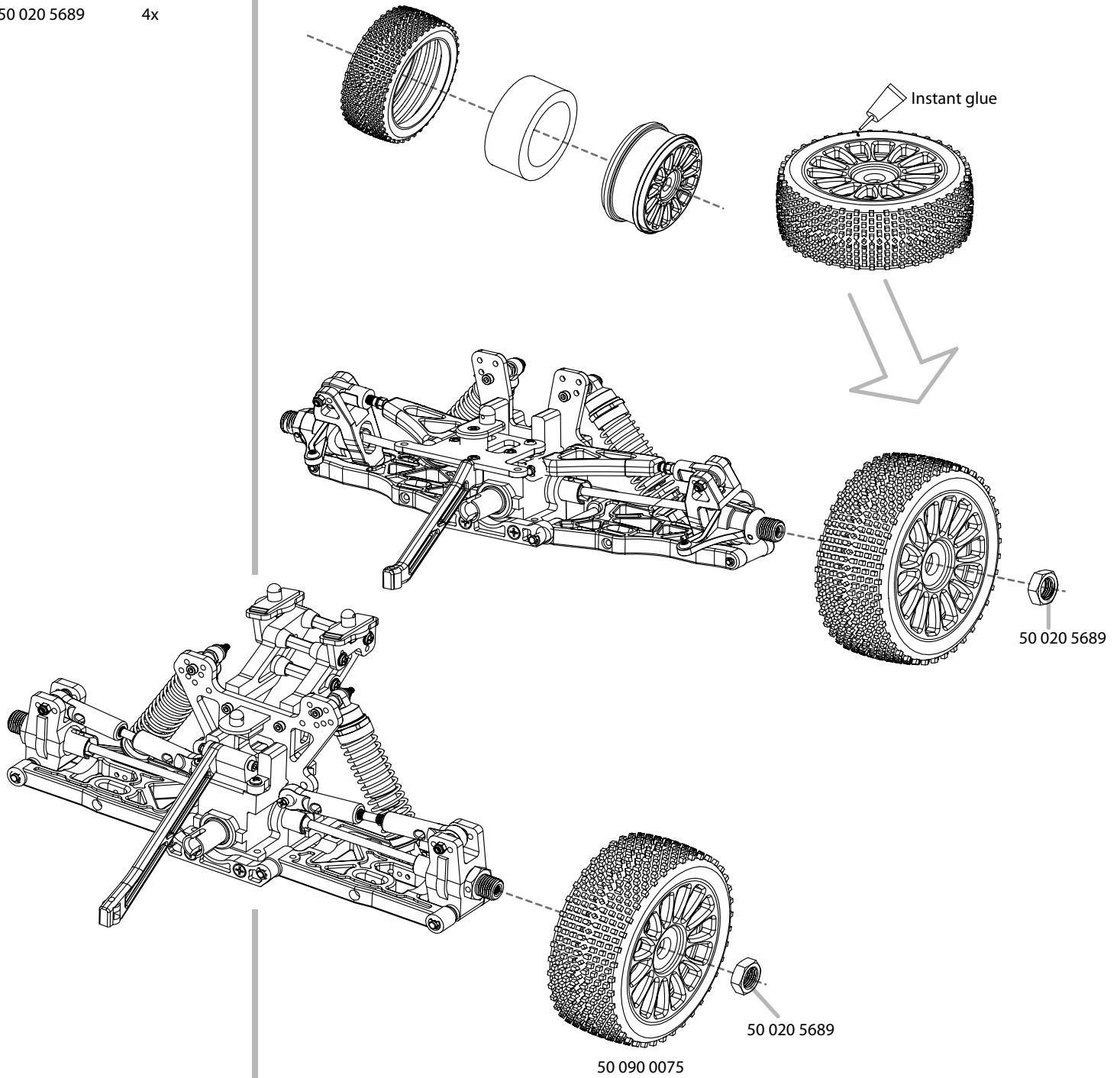

Schrauben • Screws • Vis • Tornillos • Viti

50 020 5431 Set 1

Screws for front suspension and gear box

- Schrauben für vordere Aufhängung und Getriebegehäuse
- Vis pour la suspension avant et le carter transmission
- Tornillos de suspensión delantera • Viti Sospensioni Anteriori

50 020 5431	
3.0 x 20.0 mm OKM x2	3.5 x 16.0 mm OPB x4
3.0 x 10.0 mm OPM x2	3.0 x 16.0 mm ONPD x4
3.0 x 10.0 mm OKM x6	3.0 x 25.0 mm ONMD x2
3.5 x 20.0 mm OKB x2	3.0 x 16.0 mm ONMD x2
3.5 x 45.0 mm OKB x2	4.0 x 16.0 mm OKM x4
3.5 x 10.0 mm OPB x4	3.0 x 16.0 mm OKM x1
3.0 x 16.0 mm OPM x2	

50 020 5432 Set 2

Screws for rear suspension and gear box

- Schrauben für hintere Aufhängung und Getriebegehäuse
- Vis pour la suspension arrière et le carter transmission
- Tornillos de suspensión trasera • Viti Sospensioni Posteriori

50 020 5432	
3.0 x 10.0 mm OKM x4	3.5 x 20.0 mm OKB x2
3.0 x 15.0 mm OPBD x6	3.5 x 16.0 mm OPB x4
3.0 x 22.0 mm OKM x2	3.0 x 16.0 mm ONMD x2
3.5 x 45.0 mm OKB x2	3.0 x 10.0 mm OPB x1
3.5 x 30.0 mm OPB x2	4.0 x 16.0 mm OKM x4
3.0 x 30.0 mm OPM x2	3.0 x 30.0 mm ONMD x5
	3.0 x 16.0 mm OKM x1

50 020 5433 Set 3

Screws for radio box and chassisplate • Schrauben für Empfängerbox und Chassisplatte • Vis pour le boîtier récepteur et la plaque châssis • Tornillos para la bandeja de radio y chasis • Viti per radio e Pianale

50 020 5433	
2.9 x 12.0 mm OPBD x8	2.5 x 16.0 mm OPM x1
3.0 x 10.0 mm OPB x2	2.0 x 10.0 mm OPM x1
2.0 x 8.0 mm OPB x4	2.0 x 6.0 mm OPM x2
3.0 x 13.0 mm OKB x7	3.0 x 16.0 mm OKM x1
	3.0 x 8.0 mm OKB x6

50 020 5520 Set 4

Screws for centerdiff and fuel tank • Schrauben für Mitteldifferenzial und Tankbefestigung • Vis pour le différentiel central et la fixation du réservoir carburant • Tornillos para el diferencial central y depósito • Viti differenziale Centrale e Serbatoio

50 020 5520	
3.0 x 10.0 mm OKM x4	3.0 x 16.0 mm ONMD x4
3.0 x 10.0 mm OPB x1	4.0 x 10.0 mm OKM x4
3.0 x 12.0 mm ONMD x4	3.0 x 13.0 mm OKB x2
3.0 x 8.0 mm ONMD x1	2.9 x 13.0 mm OPBD x2
3.0 x 10.0 mm OPM x4	4.0 x 16.0 mm OKM x1

Ersatzteile
Spare Parts
Pièces détachées
Recambios
Ricambi

50 020 5434 Steering rack spacer
Spacer für Lenkung

2x 2x

50 020 5435 Front bumper
Rammschutz vorne

50 020 5437 Diff gears
Diff Innenteile

2x 2x 2x 2x 4x

50 020 5438 2x Rear hub carrier
2x Radträger Hinten

50 020 5439 4x 17mm Hex hub
4x Radmitnehmer 17mm

50 020 5441 2x Rear lower arms
2x Querlenker HA unten

50 020 5442 Rear brace holder
Strebenhalter hinten

50 020 5444 Upper rear tie
Gewindest.befestigung HA

4x 2x 4x

50 020 5445 2x Wheel axle
2x Mitnehmer

50 020 5449 Front upper suspension mount
Querlenkerhalter VA oben

50 020 5451 Front chassis brace
Chassisstrebe vorne

50 020 5452 Rear chassis brace
Chassisstrebe hinten

50 020 5455 Front lower suspension mount
Querlenkerhalter VA unten

50 020 5456 Gear box
Getriebeghäuse

50 020 5457 Steel diff pinion gear
Kegelrad (Stahl)

2x 4x

50 020 5458 2x Center drive shaft front
2x Antriebswelle vorne

50 020 5459 2x Joint cup
2x Wellenmitnehmer

50 020 5460 Fuel tank mount
Tank Montage Zubehör

50 020 5463 2x Center outdrives
2x Diff Mitnehmer f. Mitteldiff







50 020 5464 Steel spur gear 46T
Hauptzahnrad 46Z

50 020 5465 Steel diff ring gear
Diff Tellerrad Stahl

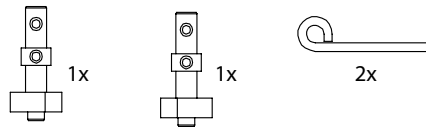
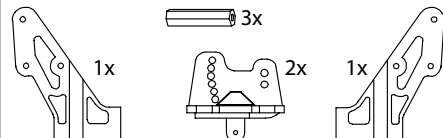
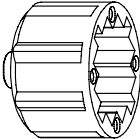
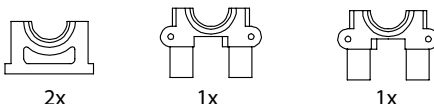
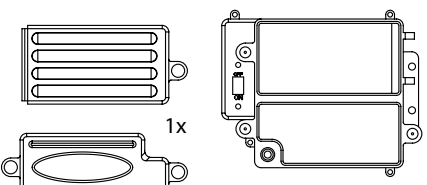
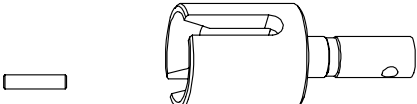

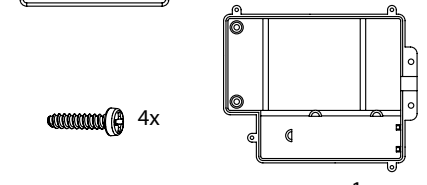
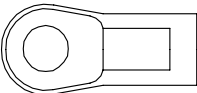
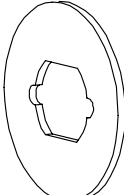
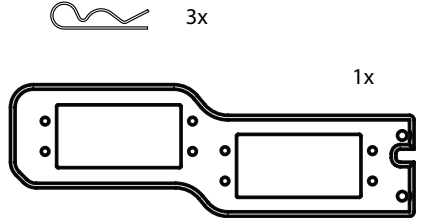
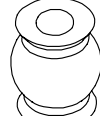
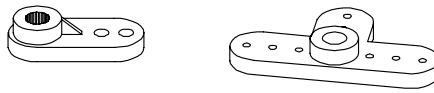

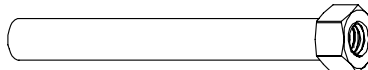
3x 1x

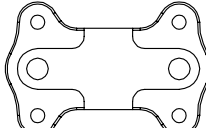
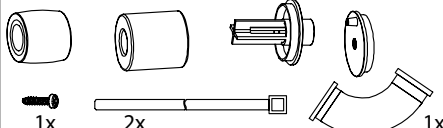
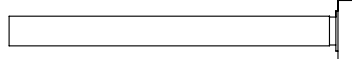
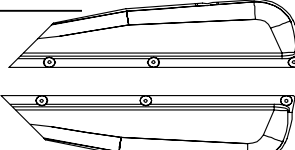
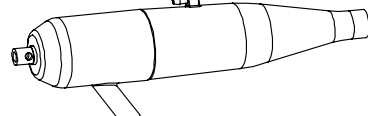
50 020 5466 4x Diff seal
4x Diff Dichtung



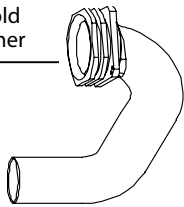
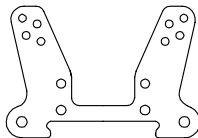
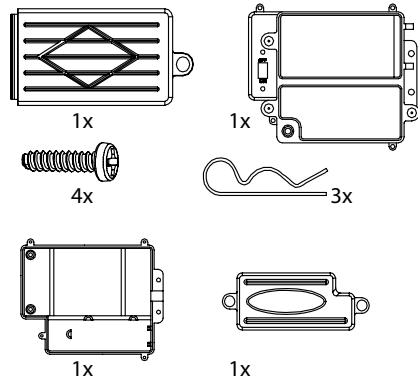
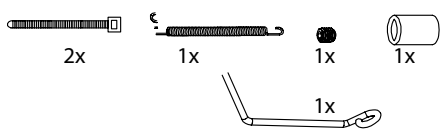
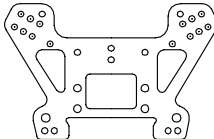
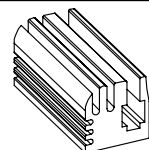
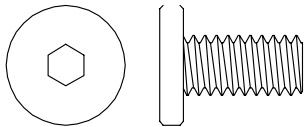
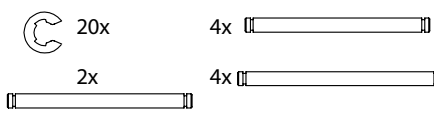
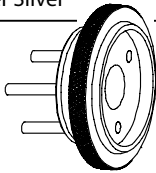
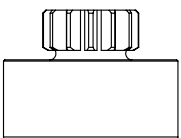

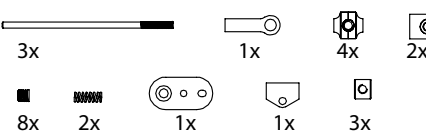
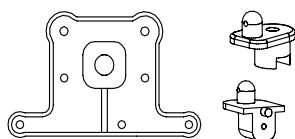
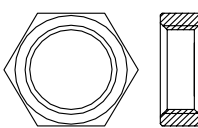
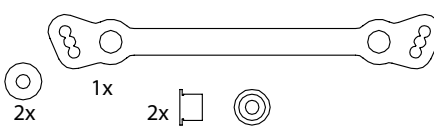
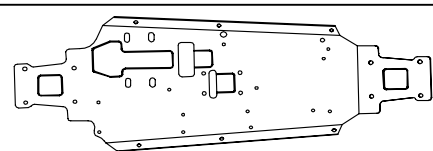
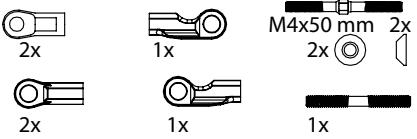
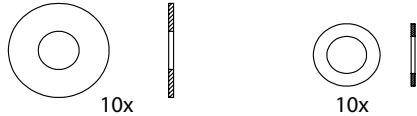

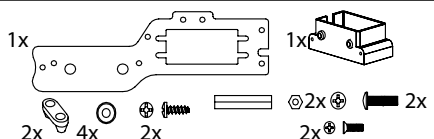
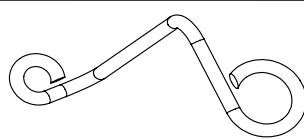

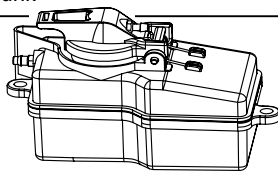
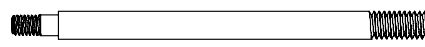
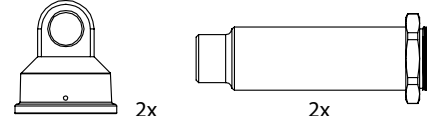
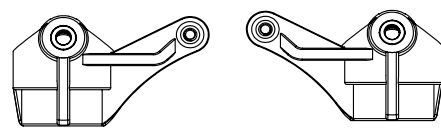

Continuation Spare Parts • Ersatzteile Fortsetzung • Continuation pièces détachées • Recambios (continuación) • Altri Ricambi

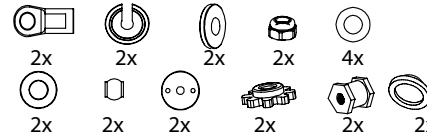
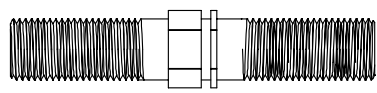
<p>50 020 5467 6x Diff gear shafts Diff Stifte f. Zahnräder</p> 	<p>50 020 5478 Front rear brake actuator Bremshebelset</p> 	<p>50 020 5486 Wing mount posts Spoilerhalterung</p> 
<p>50 020 5468 2x Diff case 2x Diff Gehäuse</p> 	<p>50 020 5479 Center bulkhead Mitteldiffträger</p> 	<p>50 020 5488 Radio box Radioplatte/Gehäuseset</p> 
<p>50 020 5469 2x Diff outdrives 2x Diff Mitnehmer</p> 	<p>50 020 5480 2x Steel brake caliper 2x Bremsbeläge</p> 	<p>50 020 5488 Radio box Radioplatte/Gehäuseset</p> 
<p>50 020 5470 4x Tie rod ends 4x Kugelpfannen</p> 	<p>50 020 5481 Brake disc Brems Scheibe</p> 	<p>50 020 5488 Radio box Radioplatte/Gehäuseset</p> 
<p>50 020 5471 4x Ball stud 4x Kugelkopf</p> 	<p>50 020 5482 Servo horns Servohörner</p> 	<p>50 020 5490 3x Clutch shoes and springs 3x Kupplungsbacken/Federn</p> 
<p>50 020 5472 Rear lower suspension mount Querlenkerhalter HA unten</p> 	<p>50 020 5483 4x Center bulkhead inserts 4x Mitteldiffpfosten</p> 	<p>50 020 5491 Center lock nut for clutch Sicherungsschraube f. Kupplung</p> 
<p>50 020 5473 Steering ball cranks Lenkung/Servosaver Teile</p> 	<p>50 020 5484 Center diff brace Mitteldiff Versteifung</p> 	<p>50 020 5493 Air filter set Luftfilter Set</p> 
<p>50 020 5475 2x Ball crank shafts 2x Lenkungspfofen</p> 	<p>50 020 5485 Splash guards left right Chassis Seitenschutz</p> 	<p>50 020 5494 Exhaust pipe Resonanzrohr</p> 

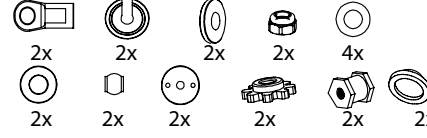
Continuation Spare Parts • Ersatzteile Fortsetzung • Continuation pièces détachées • Recambios (continuación) • Altri Ricambi

<p>50 020 5495 Mainfold Krümmer</p> 	<p>50 020 5682 Front shock tower Dämpferbrücke vorne</p> 	<p>50 020 5693 Radio box Empfänger Box</p> 
<p>50 020 5496 Exhaust set Resonanzrohr Zubehör Set</p> 	<p>50 020 5683 Rear shock tower Dämpferbrücke hinten</p> 	<p>50 020 5694 2x Engine mount silver 2x Motorhalter Silber</p> 
<p>50 020 5498 8x Engine screw 8x Motorschrauben</p> 	<p>50 020 5687 Hinge pins and clips Querlenkerstifte und Pins</p> 	<p>50 020 5695 Engine mount silver Motorhalter Silber</p> 
<p>50 020 5562 Clutch bell 14T Kupplungsglocke 14Z</p> 	<p>50 020 5688 Clutch screw Kupplungsmutter für SG-Welle</p> 	<p>50 020 5696 Throttle and brake linkage Gas- und Bremsgestänge</p> 
<p>50 020 5608 Front upper brace Verstrebung vorne oben</p> 	<p>50 020 5689 4x Hex wheel nut silver 4x Radmutter Silber</p> 	<p>50 020 5697 Steering Ackermann Ackermannplatte</p> 
<p>50 020 5679 Chassis silver Chassisplatte Silber</p> 	<p>50 020 5690 Steering tie rod Gewindestangen für Lenkung</p> 	<p>50 020 5698 10x Washers 10x Unterlegscheiben Set</p> 
<p>50 020 5691 Steering spring set Servosaver Set</p> 	<p>50 020 5692 Upperdeck kit silver Radioplatten Set Silber</p> 	<p>50 020 5699 Pullstarter holder Seilzugstarterhalter</p> 

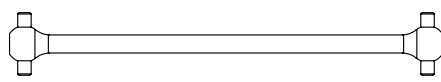
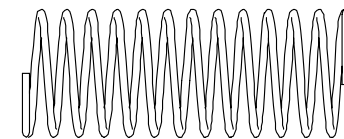
Continuation Spare Parts • Ersatzteile Fortsetzung • Continuation pièces détachées • Recambios (continuación) • Altri Ricambi

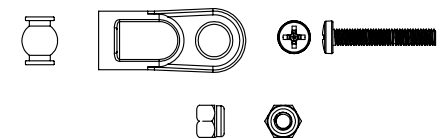
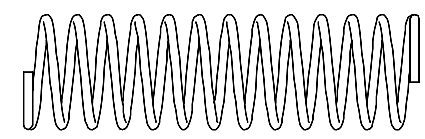
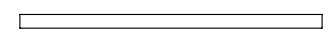
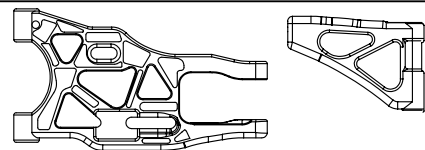
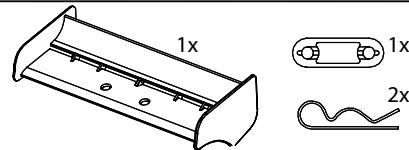
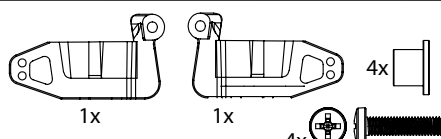
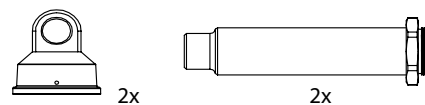
<p>50 020 5700 Fuel tank Tank</p> 	<p>50 020 5712 2x Rear shock shaft Big Bore 2x Kolbenstange hinten Big Bore</p> 	<p>50 020 5749 2x Front shock body Big Bore 2x Stoßdämpfergehäuse vo Big Bore</p> 
<p>50 020 5701 Wheel axle left + right Achsschenkel Set links + rechts</p> 	<p>50 020 5713 2x Front shock shaft Big Bore 2x Kolbenstange vorne</p> 	<p>50 020 5750 Shock parts A Big Bore Dämpferteile A Big Bore</p> 
<p>50 020 5702 2x Front upper tie rod 2x Gewindestange vorne oben</p> 	<p>50 020 5742 2x Front shock Big Bore 2x Stoßdämpfer vorne</p>  <p>Basic version</p>	<p>50 020 5751 Shock parts B Big Bore Dämpferteile B Big Bore</p> 
<p>50 020 5703 Dog bone center front rear Antriebswelle vorne hinten</p> 	<p>50 020 5743 2x Rear shock Big Bore 2x Stoßdämpfer hinten</p>  <p>Basic version</p>	<p>50 060 8013 Battery pack 4.8 V/ 1600 mAh Empfängerakkupack</p> 
<p>50 020 5704 2x Dog bone wheel 2x Antriebswelle</p> 	<p>50 020 5745 2x Front shock spring Big Bore 2x Stoßdämpferfedern vo Big Bore</p> 	<p>50 060 8037 Battery pack 6 V/ 1100 mAh Empfängerakkupack</p> 
<p>50 020 5705 2x Tie rod and ball stud 2x Kugelkopf und Pfannen</p> 	<p>50 020 5746 2x Rear shock springs Big Bore 2x Stoßdämpferfedern hi Big Bore</p> 	<p>50 090 8115 Antenna pipe Antennenrohr</p>  <p>300 mm 4x</p>
<p>50 020 5706 2x Front suspension arms 2x Querlenkerset vorne</p> 	<p>50 020 5747 Rear wing black Heckspoiler hinten schwarz</p> 	
<p>50 020 5707 Front hub carrier left + right Radträger vorne links + rechts</p> 	<p>50 020 5748 2x Rear shock body Big Bore 2x Dämpfergehäuse hinten</p> 	

Ersatzteile

Continuation Spare Parts • Ersatzteile Fortsetzung • Continuation pièces détachées • Recambios (continuación) • Altri Ricambi

50 090 0075 2x 14 Spoke pin tire black
2x 14 Speichen Pin Reifen schw.

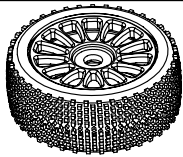

50 090 2078 5x Silicone tube for exhaust pipe
5x Silicon Dichtung für Reso Rohr

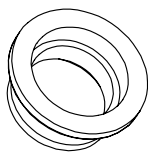

50 090 3241 Silicone fuel tube
Silicon Spritschlauch

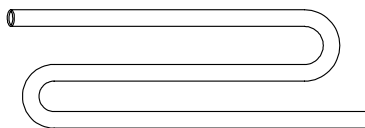

50 090 5042 Glow ignitor
Glühkerzenstecker



50 090 5072 Nitro set RTR
Nitroset RTR



50 090 8062 10x Body pins 1.5 mm
10x Karosseriesplinte 1,5 mm

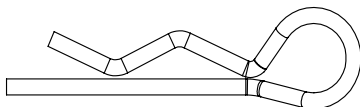

50 003 2648 Airfilter oil
Luftfilteröl



50 020 5752 Body red Specter Pro/Body blue, with decals, V21 version
Karosserie rot Specter Pro/Karosserie blau, mit Aufkleber, V21 Version



50 020 5753 Body white/yellow Specter Pro with decals, V25 version
Karosserie weiß/gelb Specter Pro mit Aufkleber, V25 Version



Ersatzteile

Silicon oli
Silikonöl

- 50 090 8048 Silicon Oil 50 ml 300
- 50 090 8049 Silicon Oil 50 ml 400
- 50 090 8050 Silicon Oil 50 ml 500
- 50 090 8051 Silicon Oil 50 ml 600
- 50 090 8052 Silicon Oil 50 ml 1000
- 50 090 8053 Silicon Oil 50 ml 3000
- 50 090 8054 Silicon Oil 50 ml 5000
- 50 090 8055 Silicon Oil 50 ml 7000



Tuningteile
Tuning parts
Pièces tuning
Piezas opcionales
Parti speciali

50 020 5303 Rear chassis brace
 Chassis Strebe Hinten

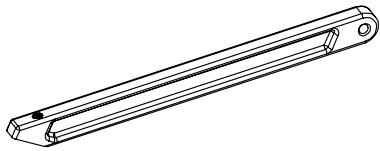

50 020 5502 Front chassis brace
 Chassis Strebe vorne

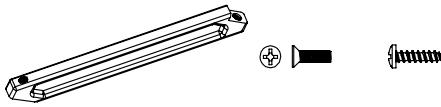

50 020 5504 Carbon rear shock tower
 Carbon Dämpferbrücke hinten

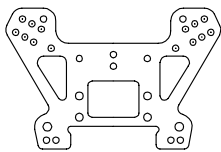

50 020 5505 Carbon front shock tower
 Carbon Dämpferbrücke vorne

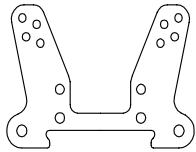

50 020 5506 Carbon steering rack
 Carbon Ackermann Platte

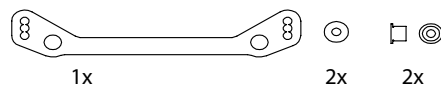

50 020 5509 Aluminium upper suspension mount
 Aluminium Querlenkerhalter VA oben

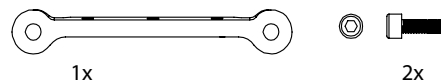

50 020 5510 Carbon center diff brace
 Carbon Strebe für Mitteldiff

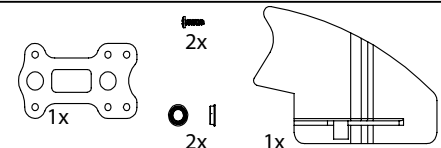

50 020 5512 Rear anti roll bar
 Stabi hinten

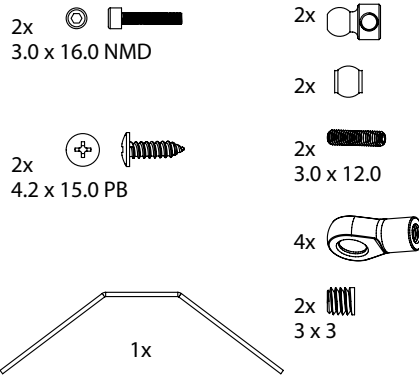

50 020 5513 Front anti roll bar
 Stabi vorne

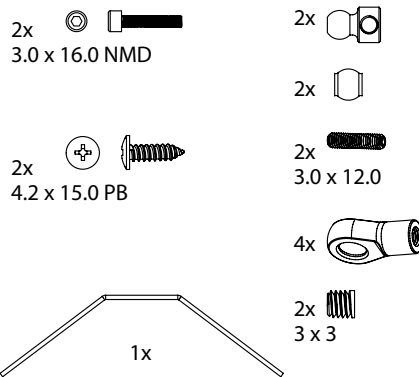

50 020 5514 2x Rear universal drive shaft
 2x Kardanwelle hinten

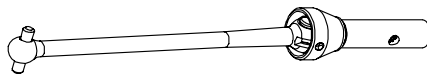

50 020 5515 2x Center universal drive shaft
 2x Kardanwelle Mitte



50 020 5516 4x Dust cover set
 4x Stoßdämpfer Schutzhülle

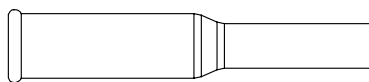

50 020 5518 2x Tuning spring set soft
 2x Stoßdämpferfedern weich



50 020 5519 2x Tuning spring set hard
 2x Stoßdämpferfedern hart



50 020 5531 2x Front shock aluminium blue
 2x Alu Stoßdämpfer blau VA



50 020 5532 2x Rear shock aluminium blue
 2x Alu Stoßdämpfer blau HA



50 020 5595 Rear wing yellow
 Heckspoiler gelb

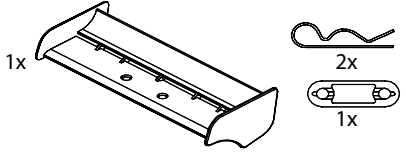

50 020 5597 Rear wing blue
 Heckspoiler blau

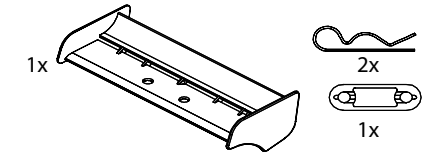

50 020 5598 Rear wing orange
 Heckspoiler orange

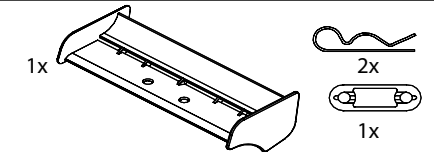

50 020 5600 2x 14 Spoke pin tyres yellow
 2x 14 Speichen Felgen m. Pin Reifen gelb

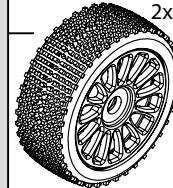

50 020 5601 2x 14 Spoke pin tyres green
 2x 14 Speichen Felgen m. Pin Reifen grün

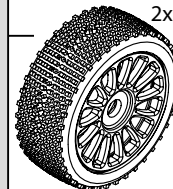

50 020 5602 2x 14 Spoke pin tyres blue
2x 14 Speichen Felgen m. Pin Reifen blau

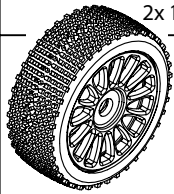

50 020 5723 Rear lower suspen. mount aluminium
Aluminium Querlenkerhalter hinten

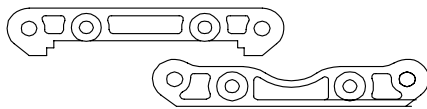

50 020 5731 Fuel tank 150 ccm
Tank 150 ccm

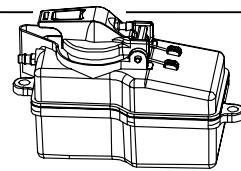

50 020 5604 2x 14 Spoke pin tyres white
2x 14 Speichen Felgen m. Pin Reifen weiß

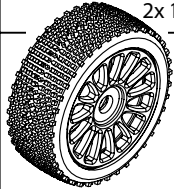

50 020 5724 Front hub carrier Pro CNC
Alu Radträger CNC gefräst VA

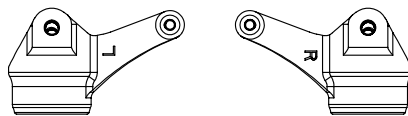

50 020 5732 Aluminium front brace
Aluminium Verstrebung vorne

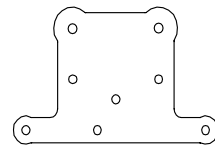

50 020 5716 Front lower suspen. mount aluminium
Aluminium Querlenkerhalter vorne

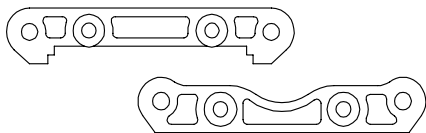

50 020 5725 Rear hubCarrier Pro CNC
Alu Radträger CNC gefräst HA

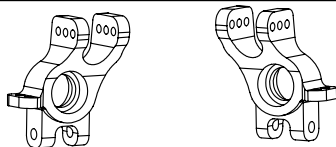

50 020 5736 Fiber glass front brace
Fiber Glass Verstrebung vorne

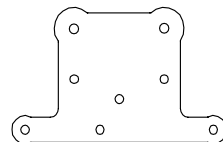

50 020 5717 4x Pin with whorl
4x Pin mit Gewinde

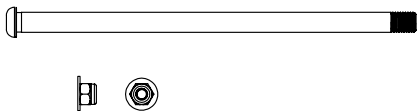

50 020 5726 Chassis titanium
Chassis Titanium

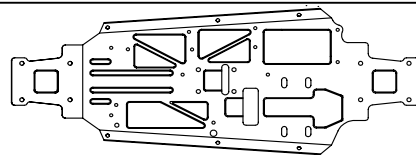

50 020 5737 Carbon front brace
Carbon Verstrebung vorne

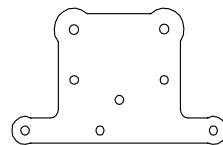

50 020 5718 Carbon fiber radio plate
Carbon Radioplatte

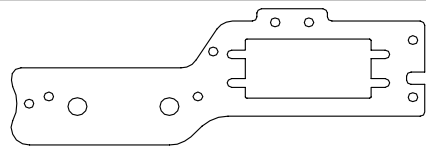

50 020 5727 2x Rear Big Bore shock 16 mm
2x Hint. Big Bore Stoßdämpfer 16mm

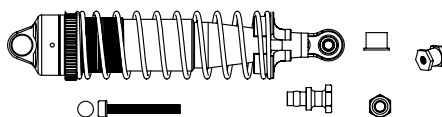

50 020 5756 2x Drive shaft front
2x Antriebswelle vorne

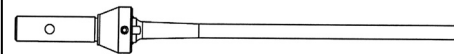

50 020 5719 2x Front steering pin
2x Pin vorne mit Gewinde

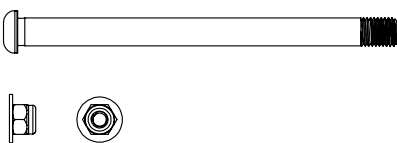

50 020 5728 Epoxy brake disc
Glasfaser Bremsscheibe

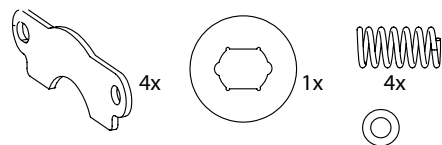

50 020 5720 2 Speedgar kit
2-Gang Set

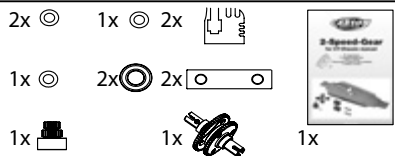

50 020 5729 4x Hinge pin
4x Pin mit Gewinde

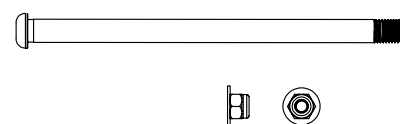

50 020 5722 2x Front Big Bore shock 16 mm
2x Vord. Big Bore Stoßdämpfer 16 mm

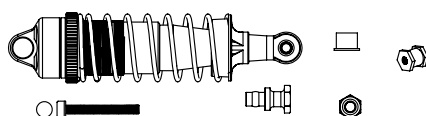

3,5 cm³

Motor • Motor • Moteur • Motor • Motore

Art.-Nr. 50 090 1004

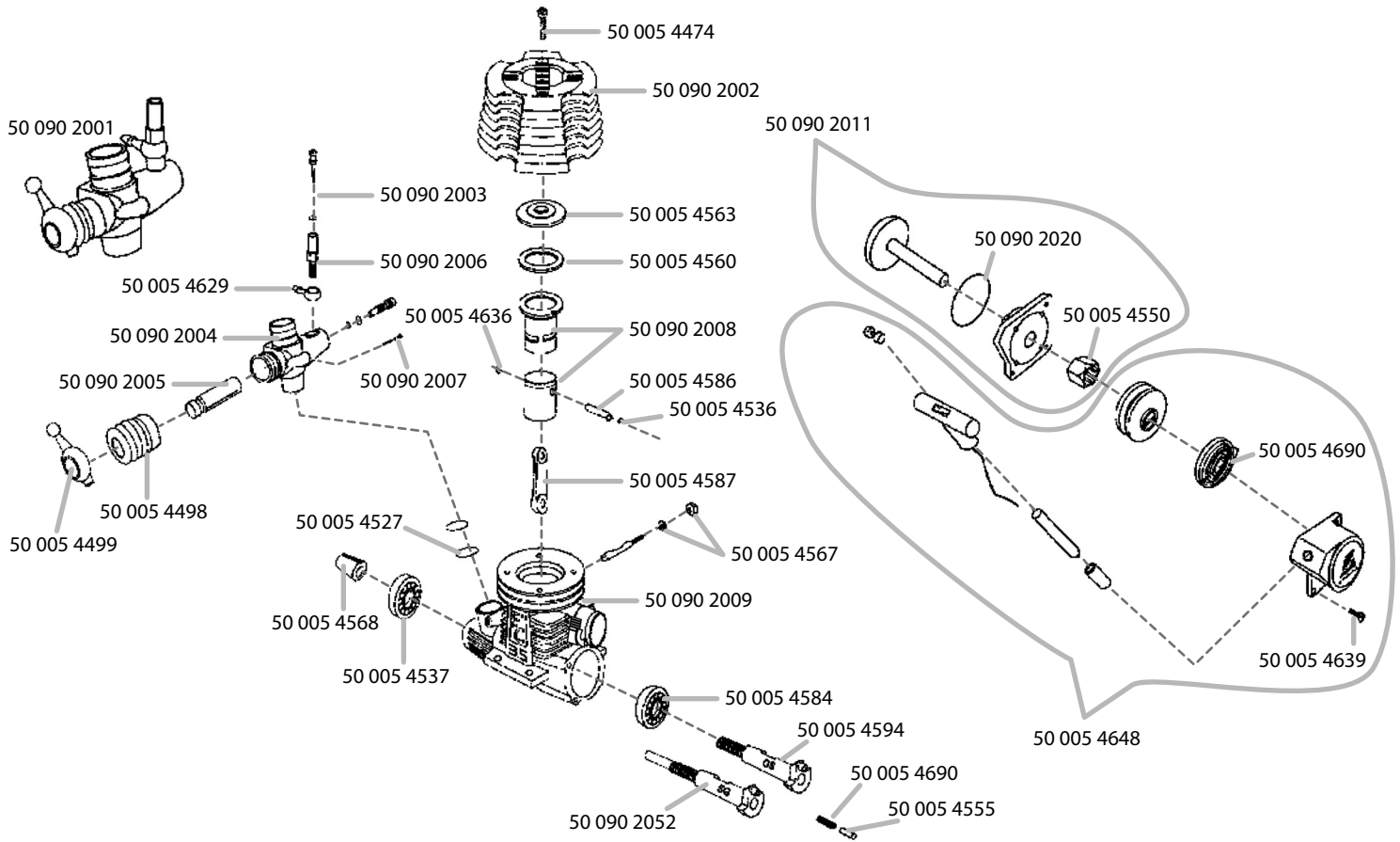

Motor

3,5 cm³ Motor • Motor • Moteur • Motor • Motore Art.-Nr. 50 090 1004

Art.-Nr.	Bezeichnung	Description	Description	Descripción	Descrizione
50 005 4474	4x Zylinderkopf-schraube M3x12 mm	4x Cylinder head screw M3x12 mm	4x Vis de fix. culasse M3x12 mm	4x Tornillos de culata	4x Viti fissaggio testa 3x12 mm
50 005 4498	Regulierungs-abdeckung	Adjuster cover	Recouvrement du palonnier	Guardapolvos de carburador	Cuffietta protezione carburatore
50 005 4499	Gestängeanschluss	Rod connector	Levier de commande	Leva de carburador	Levetta carburatore
50 005 4527	2x Vergasergehäuse-dichtung	2x Supply needle valve "O"-Ring	2x O-Ring de carburateur	2x Junta tórica aguja de bajas	2x O-ring carburatore
50 005 4536	Kolbensicherungsring	C-ring for piston pin	Pince de l'axe de piston	Clip de bulón	Seiger ferma spinotto
50 005 4537	Kugellager 607Z	Ball bearing 607Z	Roulement à billes 607Z	Rodamiento 607Z	Cuscinetto 607 Z
50 005 4550	Klemmrollen-Freilauf	One way bearing set	Roue libre avec bague de fixation	Rodamiento one-way	Cuscinetto scatto libero
50 005 4555	Starterzapfen 5,2 x 2,55 mm	Starter pivot 5.2 x 2.55 mm	Pivot starter 5,2 x 2,55 mm	Pivote de arranque 5,2 x 2,55 mm	Perno albero strappo 5,2 x 2,55 mm
50 005 4560	Zylinderkopf U-Scheibe	Washer for cylinder head	Joint de culasse	Junta de culata	Rondella sotto testa
50 005 4563	Brennraum	Combustion space	Chambre de combustion	Culatín	Sottotesta
50 005 4567	Vergasereinspannstift	Carburettor fixing pin	Vis de fix. carburateur	Pasador de fijacion carburador	Vite bloccaggio carburatore
50 005 4568	Klemmkonus	Clamping bushing	Cône	Cono de volante inercia	Cono motore
50 005 4584	Kugellager 6901	Ball bearing 6901	Roulement à billes 6901	Rodamiento 6901 13x24x6 mm	Cuscinetto 6901 13x24x6 mm
50 005 4586	Kolbenbolzen	Piston pin	Axe de piston	Bulón de pistón	Spinotto
50 005 4587	Pleuel	Connecting rod	Bielle	Biela	Biella
50 005 4594	Kurbelwelle OS 13 mm	Crankshaft OS 13 mm	Vilebrequin OS 13 mm	Cigüeñal OS	Albero OS 13 mm.
50 005 629	Kraftstoffanschluss-nippel	Fuel tube connector	Conduite d'essence	Toma de combustible	Presa ingresso miscela
50 005 639	4x Gehäusedeckelschr. M2,6 x 6 mm	4x Rear cover screw M2.6 x 6 mm	4x Vis de fix. couvercle M2,6 x 6 mm	4x Tornillo de tapa carter M2,6 x 6 mm	4x Vite tappo carter M2,6 x 6 mm
50 005 690	Feder für Seilzugstarter 7,2 x 2,4 mm	Pressure spring 7.2 x 2.4 mm	Ressort 7,2 x 2,4 mm	Muelle 7,2 x 2,4 mm	Molla albero strappo 7,2 x 2,4 mm
50 090 2001	3,5 Vergaser komplett	3.5 Carburettor complete	3.5 Carburateur complet	3,5 Carburador completo	Carburatore 3,5 completo
50 090 2002	Zylinderkopf 3,5 ccm silber	Cylinder head 3.5 ccm silver	Culasse 3,5 ccm argenté	Junta de culata 3,5 ccm	Testa Silver 3,5 ccm
50 090 2003	Hauptdüsenadel/Stock	Nozzle case	Gicleur Aguja de altas	Portaagujas	Spillo del massimo
50 090 2004	Vergasergehäuse	Carburettor case	Corps de carburateur	Muelle	Corpo carburatore
50 090 2005	Drosselventil 3,5 ccm	Throttle valve 3.5ccm	Tiroir 3,5 ccm	Guillotina 3,5 ccm	Ghigliottina 3,5 ccm
50 090 2006	Gas Einstellschraube	Needle for fuel mixture valve	Vis de reprise	Aguja de bajas	Spillo del minimo
50 090 2007	Leerlauf-Düsenadel	Idling adjuster screw	Vis de réglage ralenti	Tornillo de ralenti	Vite di arresto del minimo
50 090 2008	Laufgarnitur 4 Kanal	Cylinder liner and piston	Corps de cylindre et piston	Camisa y pistón	Cilindro e pistone
50 090 2009	Kurbelgehäuse	Crankcase	Carter du vilebrequin	Cárter	Carter
50 090 2010	Seilzugstarter	Cable pull starter	Démarrreur à tirette	Partes A del tirador de arranque	Parte A strappo
50 090 2011	Starterwelle/Deckel	Starter axle with flange	Axe du démarreur avec bride	Tirador de arranque completo	Strappo completo
50 090 2020	Gehäusedichtung hinten	Rear packing for fuel mixture	O-Ring de carter arrière	Junta de tapa de cárter	O-ring tappo carter
50 090 2052	Kurbelwelle SG	Crankshaft SG	Vilebrequin SG	Cigüeñal SG	Albero SG

Force 25R – 4,01 cm³

Motor • Motor • Moteur • Motor • Motore

Art.-Nr. 50 090 1009

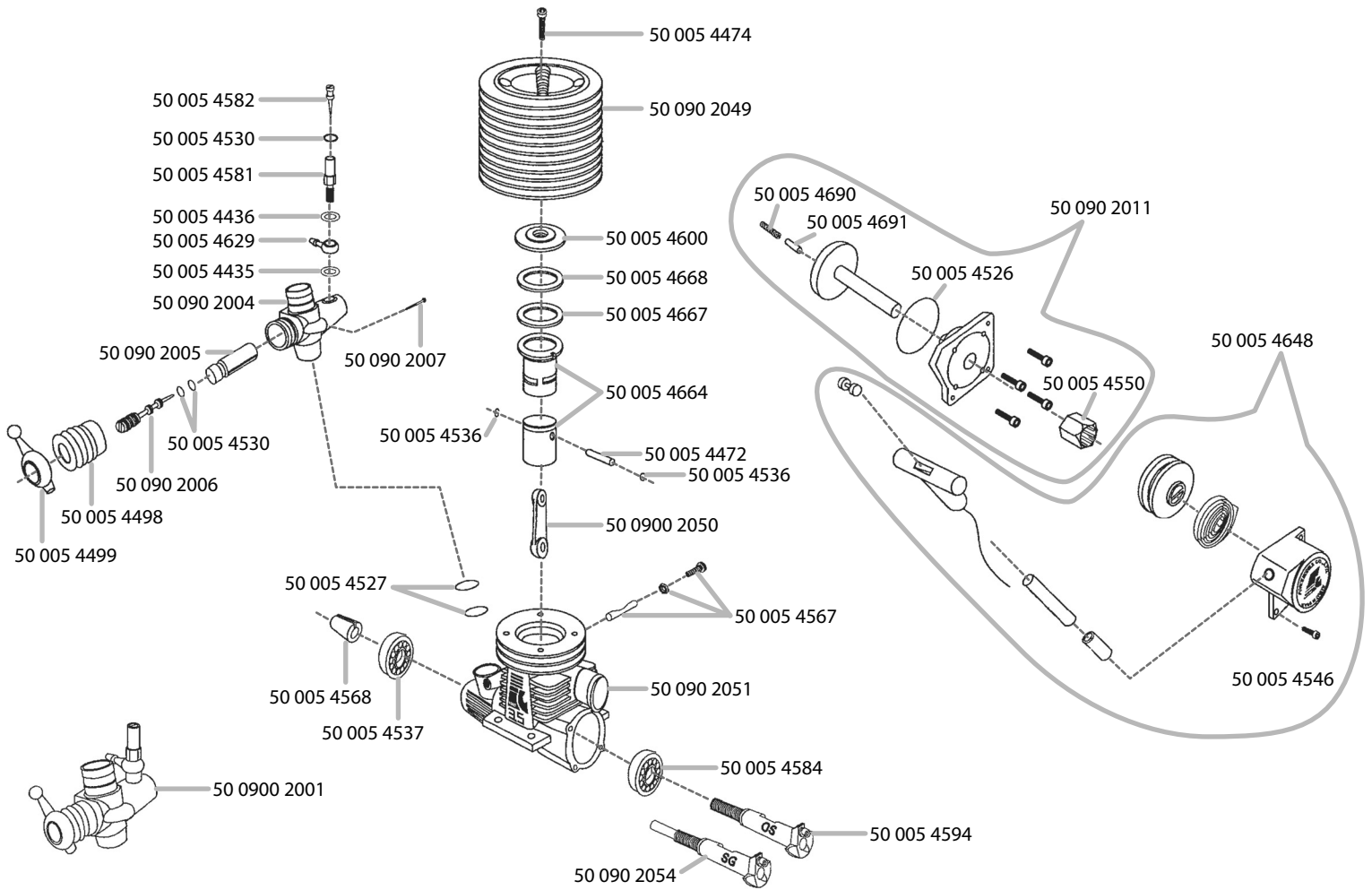

4,01 cm³ Motor • Motor • Moteur • Motor • Motore Art.-Nr. 50 090 1009

Art.-Nr.	Bezeichnung	Description	Description
50 005 4435	Düsenstockdichtung unten	Lower seal of nozzle case	Bouillage de gicleur en bas
50 005 4436	Düsenstockdichtung oben	Upper seal of nozzle case	Bouillage de gicleur superieur
50 005 4472	Kolbenbolzen	Piston gudgeon pin	Axe de piston
50 005 4474	Zylinderkopfschrauben	Cylinder head bolt	Vis de fix. Culasse 4p
50 005 4498	Regulierungsabdeckung	Throttle boot	Couvercle du palonnier
50 005 4499	Gestängeanschluss	Throttle screw cap (brass)	Levier de commande
50 005 4526	Gehäusedichtung hinten	Rear packing for fuel mixture	O-Ring de carter arriere
50 005 4527	2x Vergaser O-Ringe	2x Supply needle valve „O“-ring set	O-Ring du carburateur
50 005 4530	Hauptdüsennadel O-Ring	Main needle valve „O“-ring	O-Ring du poiteau gicleur
50 005 4536	2x Kolbensicherungsring	2x “G“-pin snap ring set	Prince de l’axe de piston
50 005 4537	Kugellager 607Z	Ball bearing 607Z	Roulement à billes 607Z
50 005 4546	4x Gehäusedeckelschr. M2,6 x 6	4x Rear cover bolt M2.6 x 6	4x Vis de fix. couvercle de carter
50 005 4550	Klemmrollen-Freilauf	One way bearing set	Roue libre avec bague de fixation
50 005 4567	Vergaser-Einspannstift	Carburetor setting pin	Vis de fix. carburateur
50 005 4568	Klemmkonus	Drive copper washer	Cône
50 005 4581	Düsenstock	Main needle seat	Gicleur
50 005 4582	Hauptdüsennadel	Main needle	Poiteau gicleur
50 005 4584	Kugellager 6901 13 x 24 x 6 mm	Ball bearing 6901 - 13 mm	Roulement à billes 6901
50 005 4594	Kurbelwelle OS	Crankshaft OS	Vilebrequin OS
50 005 4600	Brennraum 25R	Burn room	Chambre de combustion
50 005 4629	Kraftstoffanschlussnippel	Fuel nippel brass	Conduite d’essence
50 005 4648	Seilzugstarter	A parts assembly for start engine	Pièces „A“ du démarreur à tirette
50 005 4664	Laufgarnitur komplett	Cylinder sleeve/piston	Corps de cylindre et piston
50 005 4667	Zylinderkopfdichtung 0,2 mm	Cylinder head washer 0,2 mm	Joint de culasse
50 005 4668	Zylinderkopfdichtung 0,1 mm	Cylinder head washer 0.1 mm	Joint de culasse
50 005 4690	Druckfeder 7,2 x 2,4 mm	Pressure spring 7.2 x 2.4 mm	Ressort 7,5 x 2,4 mm
50 005 4691	Starterzapfen 5,2 x 2,55 mm	Starter pivot 5.2 x 2.55 mm	Pivot starter 5,2 x 2,55 mm
50 090 2001	Vergaser-Komplettset	Carburetor completely cet	Carburateur complet
50 090 2004	Vergaser-Gehäuse	Carburetor Mmain body	Corps de carburateur
50 090 2005	Drossel-Kegelventil	Throttle valve	Tiroir
50 090 2006	Drosselnadel	Throttle needle (super/turbo)	Poiteau de carburateur
50 090 2007	Leerlauf-Einstellschraube	Throttle stop adjustment screw	Vis de réglage ralenti
50 090 2011	Seilzugstarterteile mit Flansch	Recoil start unit assembly 3.5 ccm	Démarreur à tirette avec bride
50 090 2049	Zylinderkopf blau lang	Cylinder head blue	Culasse bleu longue
50 090 2050	Pleuel	Connecting rod	Bielle
50 090 2051	Kurbelwellengehäuse	Crankcase	Carter du vilebrequin
50 090 2054	Kurbelwelle SG	Crankshaft SG	Vilebrequin SG

Force 32 – 5,23 cm³
Motor • Motor • Moteur •
Motor • Motore

Art.-Nr. 50 090 1011

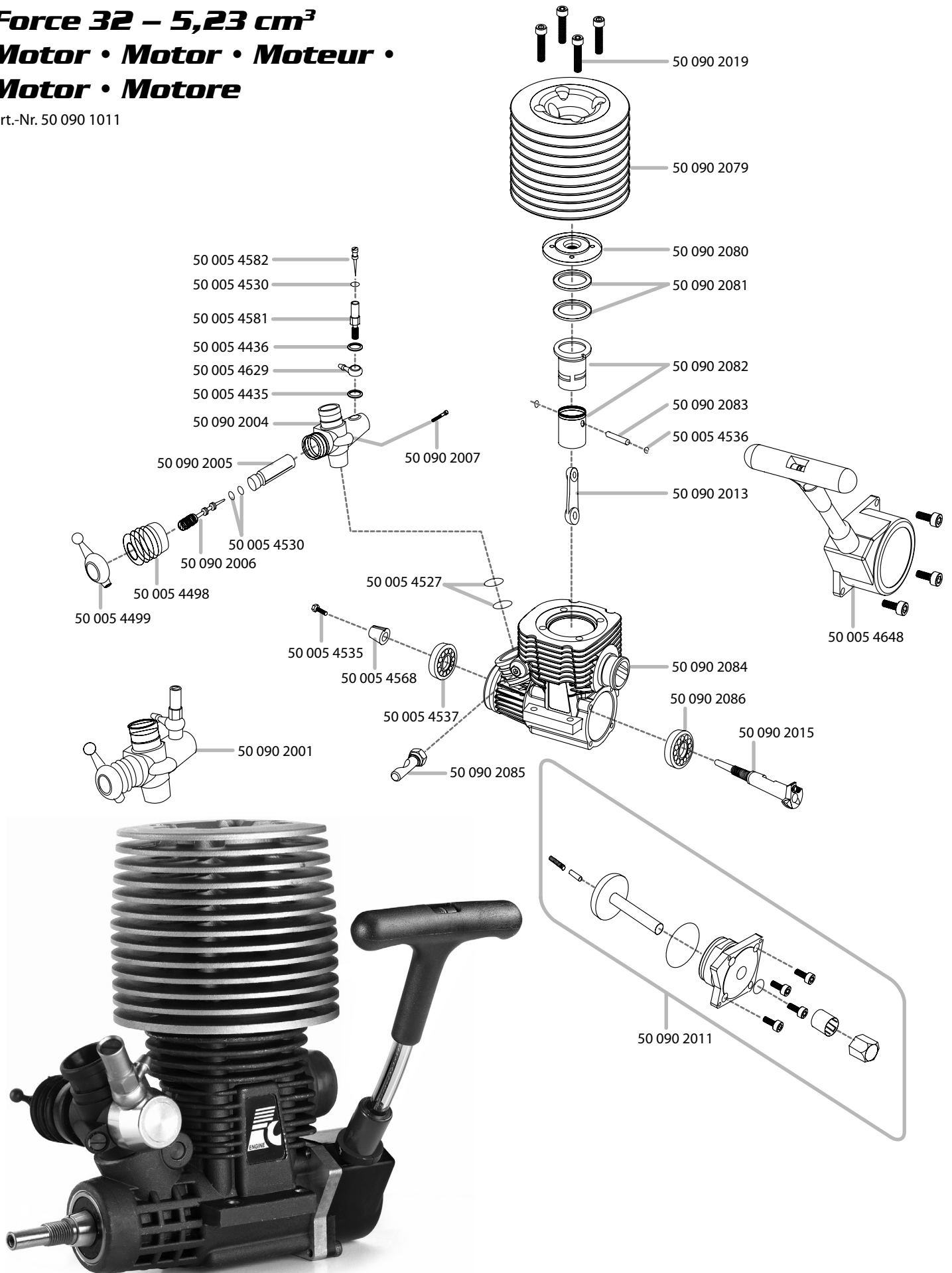

5,23 cm³ Motor • Motor • Moteur • Motor • Motore Art.-Nr. 50 090 1011

Art.-Nr.	Bezeichnung	Description	Description
50 005 4435	Düsenstockdichtung unten	Lower seal of nozzle case	Bouillage de gicleur en bas
50 005 4436	Düsenstockdichtung oben	Upper seal of nozzle case	Bouillage de gicleur superieur
50 005 4498	Regulierungsabdeckung	Throttle boot	Couvercle du palonnier
50 005 4499	Gestängeanschluss	Throttle screw cap (brass)	Levier de commande
50 005 4527	2x Vergaser O-Ringe	2x Supply needle valve „O“-ring	2x O-Ring du carburateur
50 005 4530	Hauptdüsennadel O-Ring	Main needle valve „O“-ring	O-Ring du poiteau gicleur
50 005 4535	Kupplungsschraube M3 x 6	Clutch screw M3 x 6	Vis de l'embrayage M3 x 6
50 005 4536	2x Kolbensicherungsring	2x „G“-pin snap ring set	2x Pince de l'axe de piston
50 005 4537	Kugellager 607Z vorne	Front ball bearing 607Z	Roulement à billes 607Z avant
50 005 4568	Klemmkonus	Drive copper washer	Cône
50 005 4581	Düsenstock	Main needle seat	Gicleur
50 005 4582	Hauptdüsennadel	Main needle	Poiteau gicleur
50 005 4629	Kraftstoffanschlussnippel	Fuel nippel brass	Conduite d'essence
50 005 4648	Seilzugstarter	A parts assembly for start engine	Démarrreur à tirette
50 090 2001	Vergaser komplett	Composite carburetor	Carburateur complet
50 090 2004	Vergaser-Gehäuse	Carburetor main body	Corps de carburateur
50 090 2005	Drossel-Kegelventil	Throttle valve	Tiroir
50 090 2006	Drosselnadel	Throttle needle (super/turbo)	Poiteau de carburateur
50 090 2007	Leerlauf-Einstellschraube	Throttle stop adjustmentsScrew	Vis de réglage ralenti
50 090 2013	Pleuel	Connecting rod	Bielle
50 090 2015	Kurbelwelle SG	Shaft SG	Vilebrequin SG
50 090 2019	4x Zylinderkopf-Schrauben	4x Cylinder head screws	4x Vis de fix. culasse
50 090 2079	Zylinderkopf 5,23 ccm	Cylinder head 5.23 ccm	Culasse 5,23 ccm
50 090 2080	Brennraum 32R	Burn room 32R	Chambre de combustion 32R
50 090 2081	Zylinderkopf U-Scheiben 5,23 ccm	Washer for cylinder head	Joint de culasse
50 090 2082	Zylinderlaufbuchse + Kolben 5,23 ccm	Piston & sleeve complete set	Corps de cylindre et piston
50 090 2083	Kolbenbolzen 5,23 ccm	Piston gudgeon pin	Axe de piston
50 090 2084	Kurbelgehäuse 32R	Crankcase 32R	Carter du vilebrequin 32R
50 090 2085	Vergasereinspannstift 5,23 ccm	Carburetor Setting Pin 8P	Vis de fix. carburateur
50 090 2086	Kurbelwellenlager hinten 5,23 ccm	Rear bearing	Roulement à billes arrière

Setup Sheet

Trackname: Hard Terrain Conditions/Track: Traction: High Med. Low
 Date: _____ Size: Open Med. Tight
 Driver: _____

SHOCKS	FRONT	Shock position	REAR	Shock position
	Piston <u>2.14</u>		Piston <u>2.14</u>	
	Oil # <u>250</u>		Oil # <u>200</u>	
	Spring <u>White</u>		Spring <u>White</u>	
	Spacer <u>8</u> mm		Spacer <u>16</u> mm	

SUSPENSION FRONT	 Wheel	Track width _____ mm Camber angle <u>1.5</u> ° Toe angle <u>1.0</u> ° Rebound stop <u>25</u> mm Anti-roll bar <input checked="" type="checkbox"/> use _____ mm <input type="checkbox"/> None
	 Track width	← Rebound stop

SUSPENSION REAR	 Wheel	Camber angle <u>2.5</u> ° Rebound stop <u>20</u> mm Anti-roll bar <input checked="" type="checkbox"/> use _____ mm <input type="checkbox"/> None
	 Wheelbase adjustment <u>2</u> mm	← Rebound stop
	Upper arm position 	Front

COMMENTS	_____

ENGINE	Type _____
	Plug <u>6 Rossi</u>
	Gasket <u>+0.1</u> mm
	Muffler <u>Carson Fat Lady</u>
	Fuel <u>25% Nitro Fire</u>

TIRES	Front: <u>Stock #205428</u>
	Foam(Front): <u>Std</u>
Rear: <u>Stock #205428</u>	
Foam(Rear): <u>Std</u>	

CLUTCH	Clutch shoes <input type="checkbox"/> Aluminium <input checked="" type="checkbox"/> Other <u>Std</u>
	Spring <u>1.2</u> mm
	Clutch bell / Spur gear <u>14/46</u>

DIFF OIL	Front # <u>50000</u> -Ring <u>Yes</u>
	Center # <u>10000</u> <u>Yes</u>
	Rear # <u>1000</u> <u>Yes</u>

WING	
-------------	--

STEERING REKERMANN	
---------------------------	--

RESULT	Racetime/ Lap _____
	Best Lap _____

Setup Sheet



Trackname: Soft Terrain Conditions/Track: Traction: High Med. Low
 Date: _____ Size Open Med. Tight
 Driver: _____

SHOCKS

FRONT
 Piston 2 x 14
 Oil # 350
 Spring Blue
 Spacer 12 mm

Shock position

REAR
 Piston 2 x 14
 Oil # 300
 Spring Blue
 Spacer 20 mm

Shock position

SUSPENSION FRONT

Track width _____ mm
 Camber angle 1.0°
 Toe angle 1.0°
 Rebound stop 28 mm
 Anti-rol bar use _____ mm
 None

Wheel

Rebound stop

Track width

SUSPENSION REAR

Camber angle 3°
 Rebound stop 20 mm
 Anti-rol bar use _____ mm
 None

Wheel

Rebound stop

Upper arm position

Wheelbase adjustment 2 mm

Front

COMMENTS

ENGINE

Type _____
 Plug 6 Rossi
 Gasket +0.1 mm
 Muffler Carson Fat Lady
 Fuel 25% Nitro Fire

TIRE

Front: Stock #205428
 Foam(Front): Std

Rear: Stock #205428
 Foam(Rear): Std

CLUTCH

Clutch shoes Aluminium
 Other Std
 Spring 1.2 mm
 Clutch bell / Spur gear 14/46

DIFF OIL

Front # 3000 O-Ring Yes
 Center # 7000 Yes
 Rear # 2000 Yes

WING

STEERING ACKERMANN

RESULT

Racetime/ Lap _____
 Best Lap _____



**For Germany:
Service-Hotline:**

Mo - Do 8.00 - 17.00 Uhr

Fr 8.00 - 14.30 Uhr

CARSON-Model Sport

Abt. Service

Mittlere Motsch 9

96515 Sonneberg

01805-73 33 00

14 ct/min



CARSON-MODEL SPORT

Werkstraße 1 • D-90765 Fürth • Germany

www.carson-modelsport.de